



Maintenance and Service Guide

SUMMARY

This guide provides information about spare parts, removal and replacement of parts, security, backing up, and more.

Legal information

© Copyright 2022 HP Development Company, L.P.

AMD, Radeon, and Ryzen are trademarks of Advanced Micro Devices, Inc. Bluetooth is a trademark owned by its proprietor and used by HP Inc. under license. Intel is a trademark of Intel Corporation or its subsidiaries in the U.S. and/or other countries. Microsoft and Windows are either registered trademarks or trademarks of Microsoft Corporation in the United States and/or other countries. NVIDIA, GeForce, and Optimus are trademarks and/or registered trademarks of NVIDIA Corporation in the U.S. and other countries. Qualcomm is a trademark of Qualcomm Incorporated, registered in the United States and other countries, used with permission. SDHC, SDXC, and microSD are trademarks or registered trademarks of SD-3C LLC. USB Type-C and USB-C are registered trademarks of USB Implementers Forum. Miracast and Wi-Fi are registered trademarks of Wi-Fi Alliance.

The information contained herein is subject to change without notice. The only warranties for HP products and services are set forth in the express warranty statements accompanying such products and services. Nothing herein should be construed as constituting an additional warranty. HP shall not be liable for technical or editorial errors or omissions contained herein.

First Edition: April 2022

Document Part Number: N06393-001

Product notice

This guide describes features that are common to most models. Some features may not be available on your computer.

Not all features are available in all editions or versions of Windows. Systems may require upgraded and/or separately purchased hardware, drivers, software or BIOS update to take full advantage of Windows functionality. Windows is automatically updated, which is always enabled. High-speed internet and Microsoft account required. ISP fees may apply and additional requirements may apply over time for updates. See <http://www.windows.com>. **If your product ships with Windows in S Mode:** Windows in S Mode works exclusively with apps from the Microsoft Store within Windows. Certain default settings, features, and apps cannot be changed. Some accessories and apps that are compatible with Windows may not work (including some antivirus, PDF writers, driver utilities, and accessibility apps), and performance may vary, even if you switch out of S Mode. If you switch to Windows, you cannot switch back to S Mode. Learn more at [Windows.com/SmodeFAQ](https://www.windows.com/SmodeFAQ).

To access the latest user guides, go to <http://www.hp.com/support>, and follow the instructions to find your product. Then select **Manuals**.

Software terms

By installing, copying, downloading, or otherwise using any software product preinstalled on this computer, you agree to be bound by the terms of the HP End User License Agreement (EULA). If you do not accept these license terms, your sole remedy is to return the entire unused product (hardware and software) within 14 days for a full refund subject to the refund policy of your seller.

For any further information or to request a full refund of the price of the computer, please contact your seller.

Safety warning notice

Reduce the possibility of heat-related injuries or of overheating the computer by following the practices described.

-
-  **WARNING!** To reduce the possibility of heat-related injuries or of overheating the computer, do not place the computer directly on your lap or obstruct the computer air vents. Use the computer only on a hard, flat surface. Do not allow another hard surface, such as an adjoining optional printer, or a soft surface, such as pillows or rugs or clothing, to block airflow. Also, do not allow the AC adapter to come into contact with the skin or a soft surface, such as pillows or rugs or clothing, during operation. The computer and the AC adapter comply with the user-accessible surface temperature limits defined by applicable safety standards.
-

Table of contents

1 Product description.....	1
2 Getting to know your computer.....	5
Right side.....	5
Left side.....	6
Display.....	7
Low blue light mode (select products only).....	7
Keyboard area.....	9
Touchpad settings and components.....	9
Touchpad settings.....	9
Adjusting touchpad settings.....	9
Turning on the touchpad.....	9
Touchpad components.....	10
Lights.....	11
Button.....	12
Special keys.....	13
Bottom.....	15
Rear.....	16
Labels.....	16
3 Illustrated parts catalog.....	18
Computer major components.....	18
Display assembly subcomponents.....	21
Miscellaneous parts.....	22
4 Removal and replacement procedures preliminary requirements.....	25
Tools required.....	25
Service considerations.....	25
Plastic parts.....	25
Cables and connectors.....	25
Drive handling.....	25
Electrostatic discharge information.....	26
Generating static electricity.....	26
Preventing electrostatic damage to equipment.....	27
Personal grounding methods and equipment.....	27
Grounding the work area.....	28
Recommended materials and equipment.....	28
Cleaning your computer.....	29
Enabling HP Easy Clean (select products only).....	29
Removing dirt and debris from your computer.....	29

Cleaning your computer with a disinfectant	30
Caring for wood veneer (select products only)	31
Packaging and transporting guidelines	31
Accessing support information	32
5 Removal and replacement procedures for Customer Self-Repair parts.....	34
Component replacement procedures.....	34
Preparation for disassembly	34
Solid-state drive	34
Memory modules.....	36
6 Removal and replacement procedures for authorized service provider parts.....	38
Component replacement procedures.....	38
Preparation for disassembly	38
Bottom cover	38
Battery	40
Display subcomponents (without removing the display)	41
WLAN module	45
Speakers	46
Fan assembly	47
Power connector cable	48
I/O board	49
Card reader	50
Heat sink	51
System board.....	52
Touchpad	55
Plastic rear vent and fin.....	57
Display assembly.....	58
Top cover with keyboard.....	64
7 Using Setup Utility (BIOS)	66
Starting Setup Utility (BIOS)	66
Updating Setup Utility (BIOS)	66
Determining the BIOS version	66
Preparing for a BIOS update	67
Downloading a BIOS update	67
Installing a BIOS update	67
8 Backing up, restoring, and recovering	69
Backing up information and creating recovery media.....	69
Using Windows tools for backing up	69
Using the HP Cloud Recovery Download Tool to create recovery media (select products only).....	69
Restoring and recovering your system	70
Creating a system restore	70
Restoring and recovery methods	70
Recovering using HP Recovery media	70
Changing the computer boot order	71
Using HP Sure Recover (select products only)	71

9 Using HP PC Hardware Diagnostics	72
Using HP PC Hardware Diagnostics Windows (select products only)	72
Using an HP PC Hardware Diagnostics Windows hardware failure ID code	72
Accessing HP PC Hardware Diagnostics Windows	72
Accessing HP PC Hardware Diagnostics Windows from HP Support Assistant	72
Accessing HP PC Hardware Diagnostics Windows from the Start menu (select products only)	73
Downloading HP PC Hardware Diagnostics Windows	73
Downloading the latest HP PC Hardware Diagnostics Windows version from HP	73
Downloading the HP PC Hardware Diagnostics Windows from the Microsoft Store	73
Downloading HP Hardware Diagnostics Windows by product name or number (select products only)	73
Installing HP PC Hardware Diagnostics Windows	74
Using HP PC Hardware Diagnostics UEFI	74
Using an HP PC Hardware Diagnostics UEFI hardware failure ID code	74
Starting HP PC Hardware Diagnostics UEFI	74
Downloading HP PC Hardware Diagnostics UEFI to a USB flash drive	75
Downloading the latest HP PC Hardware Diagnostics UEFI version	75
Downloading HP PC Hardware Diagnostics UEFI by product name or number (select products only)	75
Using Remote HP PC Hardware Diagnostics UEFI settings (select products only)	76
Downloading Remote HP PC Hardware Diagnostics UEFI	76
Downloading the latest Remote HP PC Hardware Diagnostics UEFI version	76
Downloading Remote HP PC Hardware Diagnostics UEFI by product name or number	76
Customizing Remote HP PC Hardware Diagnostics UEFI settings	76
10 Specifications	78
Computer specifications	78
Display specifications	79
Solid-state drive specifications	79
11 Power cord set requirements	81
Requirements for all countries	81
Requirements for specific countries and regions	81
12 Recycling	83
Index	84

1 Product description

This table provides detailed product information.

Table 1-1 Product components and their descriptions

Category	Description
Product Name	Victus by HP 15.6 inch Gaming Laptop Model numbers: 15-fb0xxx CTO: 15z-fb000
Processor	AMD Ryzen™ processors AMD Ryzen 7-5800H (3.2 GHz [turbo up to 4.4 GHz], 8 cores, 16 MB L3 cache, 45 W) AMD Ryzen 5-5600H (3.3 GHz [turbo up to 4.2 GHz], 6 cores, 16 MB L3 cache, 45 W)
Graphics controller	Integrated graphics AMD Radeon™ Graphics Hybrid graphics <ul style="list-style-type: none">• NVIDIA® GeForce® RTX 3050 graphics• NVIDIA GeForce RTX 3050Ti graphics• AMD Radeon RX6500M graphics• NVIDIA GeForce GTX 1650 graphics Supports HD decode, DX12, and HDMI Supports Optimus® Support for FreeSync (internal and external) MR compatible (60 Hz frame rate)
Display	39.6 cm (15.6 in), liquid crystal display (LCD), white light-emitting diode (WLED), antiglare flat, flicker free Full high definition (FHD) (1920 × 1080), standard viewing angle (SVA), 45% NTSC, embedded DisplayPort (eDP) 1.2 without panel self-refresh (PSR), 250 nits FHD, ultrawide viewing angle (UWVA), 45% NTSC, eDP 1.2 without PSR, 250 nits FHD, UWVA, eDP 1.3 + PSR, 45% NTSC, 250 nits, 144 Hz FHD, UWVA, 100% sRGB, eDP 1.4 + PSR2, low blue light, 300 nits
Memory	Two memory slots supporting up to 16 GB of RAM DDR4-3200 Supports the following configurations: <ul style="list-style-type: none">• 16 GB (8 GB × 2)• 12 GB (8 GB + 4 GB)• 8 GB (8 GB × 1 or 4 GB × 2)

Table 1-1 Product components and their descriptions (continued)

Category	Description
Primary storage	M.2 solid-state drive (PCIe-3 × 4, 2280, non-volatile memory express (NVMe), three-layer cell (TLC)
	1 TB
	512 GB
	256 GB
Audio	Audio brand: Bang & Olufsen
	Dual speakers
	Supports HP Audio Boost
Video	HP Wide Vision HD camera - indicator LED, USB 2.0, HD BSI sensor, f2.0, 88° wide field-of-view (WFOV)
	720p by 30 frames per second (fps)
	Dual-array, digital microphone with appropriate software - beam forming, echo cancellation, noise suppression
Wireless networking	Wireless Local Area Network (WLAN) with dual antennas
	<ul style="list-style-type: none"> MediaTek Wi-Fi® 6 MT7921 + Bluetooth® 5.2 (802.11ax 2 × 2, MU-MIMO supported, supporting gigabit data rate) MediaTek Wi-Fi 6E RZ616 + Bluetooth 5.2 (802.11ax 2 × 2, MU-MIMO supported, supporting gigabit data rate)
	Support for Miracast®
	Support for Modern Standby (connected)
RJ-45 (network)	Integrated 10/100/1000 NIC
Ports	Hot plug/unplug and auto detect for correct output to wide-aspect vs standard aspect video
	Audio-out (headphone)/audio-in (microphone) combo jack
	RJ-45 (network) jack
	AC Smart pin adapter plug
	HDMI 2.1 out
	- output up to 8 K @ 60 Hz with HDCP 2.3 (3050 Ti/3050)
	- output up to 4 K @ 60 Hz with HDCP 2.2 (1650)
	(2) USB 3.2 Gen 1 Type-A port; left side supports HP Sleep & Charge
	USB 3.2 Type-C Gen1 port, supports:
	- Display Port 1.4 out up to 5 K (60 Hz)
	- Data transfer
	- HDMI 2.1 output up to 5 K @ 60 Hz with HDCP 2.3
- HP Sleep & Charge	
Media card reader	HP Multi-Format Digital Media Card Reader
	Supports MicroSD™/SDHC™/SDXC™
	Push-push insertion/removal

Table 1-1 Product components and their descriptions (continued)

Category	Description
Keyboard/pointing devices	Keyboard
	Full size, island style, backlit keyboard with numeric keypad
	Clickpad with image sensor
	Multitouch gestures enabled
	Precision touchpad supported
	Supports modern trackpad gestures
	Taps enabled as default
Power requirements	Battery
	4 cell, 70 Whr
	3 cell, 52.5 Whr
	Long life
	Fast charge
	HP Smart AC adapter (4.5 mm, power correction factor [PFC])
	200 W, slim, right angle, 3 pin
	150 W, slim barrel
	Power cord
	C13, premium, 1.0 m (3.3 ft)
C5, conventional, 1.0 m (3.3 ft)	
Security	Trusted Platform Module (TPM) 2.0

Table 1-1 Product components and their descriptions (continued)

Category	Description
Operating system	Windows® 11 Home 64
	Windows 11 Home 64 Advanced
	Windows 11 Home 64 Advanced Single Language
	Windows 11 Home 64 Chinese Market CPPP
	Windows 11 Home 64 High-End Chinese Market CPPP
	Windows 11 Home 64 Plus
	Windows 11 Home 64 Plus Single Language
	Windows 11 Home 64 Plus Single Language Africa Market PPP
	Windows 11 Home 64 Plus Single Language APAC EM PPP
	Windows 11 Home 64 Plus Single Language India Market PPP
	Windows 11 Home 64 Plus Single Language Indonesia Market PPP
	Windows 11 Home 64 Single Language
	Windows 11 Home 64 Single Language Africa Market PPP
	Windows 11 Home 64 Single Language APAC EM PPP
	Windows 11 Home 64 Single Language India Market PPP
	Windows 11 Home 64 Single Language Indonesia Market PPP
	Windows 11 Pro 64
	FreeDOS 3.0
Serviceability	AC adapter
	Solid-state drive
	Memory modules

2 Getting to know your computer

Your computer features top-rated components. This chapter provides details about your components, where they are located, and how they work.

Right side

Identify the components on the right side of the computer.

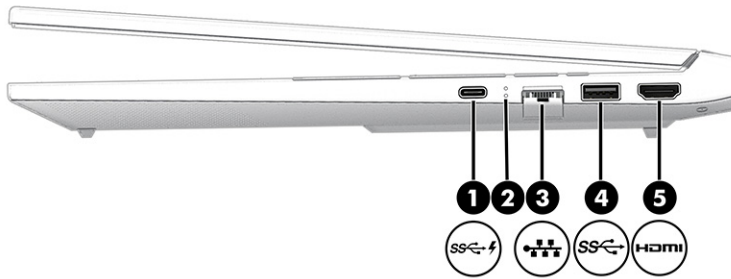

Table 2-1 Right-side components and their descriptions





Component	Description
(1) 	<p>USB Type-C® SuperSpeed 5 Gbps port with HP Sleep and Charge and DisplayPort™ output</p> <p>NOTE: Use a standard USB Type-C charging cable or cable adapter (purchased separately) when charging a small external device.</p> <p>– and –</p> <p>Connects a display device that has a USB Type-C connector, providing DisplayPort output.</p>
(2)	<p>RJ-45 (network) status lights</p> <ul style="list-style-type: none">• White: The network is connected.• Amber: Activity is occurring on the network.
(3) 	<p>RJ-45 (network) jack</p> <p>Connects a network cable.</p>
(4) 	<p>USB SuperSpeed 5 Gbps port</p> <p>Connects a USB device, provides high-speed data transfer, and (for select products) charges small devices (such as a smartphone) when the computer is on or in Sleep mode.</p> <p>NOTE: Use a standard USB Type-A charging cable or cable adapter (purchased separately) when charging a small external device.</p>

Table 2-1 Right-side components and their descriptions (continued)

Component	Description
(5)  HDMI port	Connects an optional video or audio device, such as a high-definition television, any compatible digital or audio component, or a high-speed High-Definition Multimedia Interface (HDMI) device.

Left side

Identify the components on the left side of the computer.

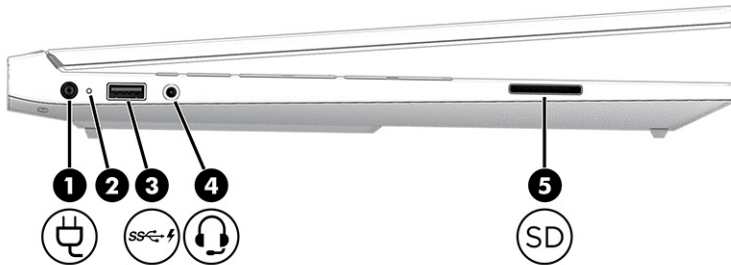

Table 2-2 Left-side components and their descriptions





Component	Description
(1) 	Connects an AC adapter.
(2) AC adapter and battery light	<ul style="list-style-type: none"> White: The AC adapter is connected and the battery is fully charged. Blinking amber: The AC adapter is disconnected and the battery has reached a low battery level. Amber: The AC adapter is connected and the battery is charging. Off: The battery is not charging.
(3)  USB SuperSpeed 5 Gbps port with HP Sleep and Charge	<p>Connects a USB device, provides high-speed data transfer, and charges small devices (such as a smartphone), even when the computer is off.</p> <p>NOTE: Use a standard USB Type-A charging cable or cable adapter (purchased separately) when charging a small external device.</p>

Table 2-2 Left-side components and their descriptions (continued)

Component	Description
(4)  Audio-out (headphone)/Audio-in (microphone) combo jack	<p>Connects optional powered stereo speakers, headphones, earbuds, a headset, or a television audio cable. Also connects an optional headset microphone. This jack does not support optional standalone microphones.</p> <p>WARNING! To reduce the risk of personal injury, adjust the volume before putting on headphones, earbuds, or a headset. For additional safety information, see the <i>Regulatory, Safety, and Environmental Notices</i>.</p> <p>To access this guide:</p> <ul style="list-style-type: none">■ Select the Search icon in the taskbar, type HP Documentation in the search box, and then select HP Documentation. <p>NOTE: When a device is connected to the jack, the computer speakers are disabled.</p>
(5)  Memory card reader (select products only)	<p>Reads optional memory cards that enable you to store, manage, share, or access information.</p> <p>To insert a card:</p> <ol style="list-style-type: none">1. Hold the card label-side up, with connectors facing the computer.2. Insert the card into the memory card reader, and then press in on the card until it is firmly seated. <p>To remove a card:</p> <ul style="list-style-type: none">■ Press in on the card, and then remove it from the memory card reader.

Display

The computer display can include essential components such as speakers, antennas, cameras, and microphones.

Low blue light mode (select products only)

Your computer display is shipped from the factory in low blue light mode for improved eye comfort and safety. Also, blue light mode automatically adjusts blue light emissions when you are using the computer at night or for reading.

⚠ WARNING! To reduce the risk of serious injury, read the *Safety & Comfort Guide*. It describes proper workstation setup and proper posture, health, and work habits for computer users. The *Safety & Comfort Guide* also provides important electrical and mechanical safety information. The *Safety & Comfort Guide* is available on the web at <http://www.hp.com/ergo>.

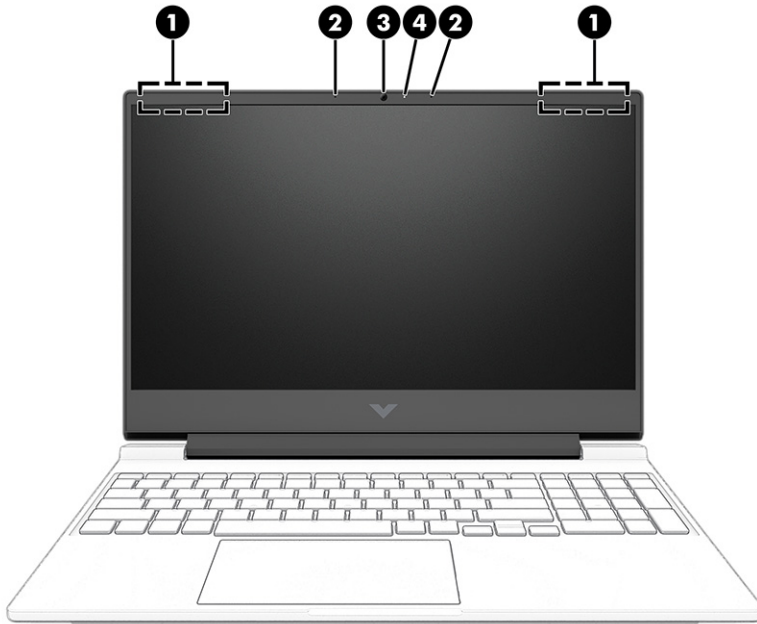

Table 2-3 Display components and their descriptions

Component		Description
(1)	WLAN antennas*	Send and receive wireless signals to communicate with wireless local area networks (WLANs).
(2)	Internal microphones (2)	Record sound.
(3)	Camera	Allows you to video chat, record video, and record still images. Some cameras also allow a facial recognition logon to Windows, instead of a password logon. NOTE: Camera functions vary depending on the camera hardware and software installed on your product.
(4)	Camera light	On: The camera is in use.

Table 2-3 Display components and their descriptions (continued)

Component	Description
	<p>*The antennas are not visible from the outside of the computer. For optimal transmission, keep the areas immediately around the antennas free from obstructions.</p> <p>For wireless regulatory notices, see the section of the <i>Regulatory, Safety, and Environmental Notices</i> that applies to your country or region.</p> <p>To access this guide:</p> <ul style="list-style-type: none">■ Select the Search icon in the taskbar, type <code>HP Documentation</code> in the search box, and then select HP Documentation.

Keyboard area

Keyboards can vary by language.



NOTE: The keyboard area, including the function keys and (select products only) power key, is disabled in stand, tent, and tablet modes. To enable the keyboard, including the power key, change to the clamshell mode.

Touchpad settings and components

Learn the touchpad settings and components.

Touchpad settings

Learn how to adjust touchpad settings.

Adjusting touchpad settings

Use these steps to adjust touchpad settings and gestures.

1. Select the **Search** icon in the taskbar, type `touchpad settings` in the search box, and then press **enter**.
2. Choose a setting.

Turning on the touchpad

Follow these steps to turn on the touchpad.

1. Select the **Search** icon in the taskbar, type `touchpad settings` in the search box, and then press **enter**.

- Using an external mouse, click the **touchpad** button.

If you are not using an external mouse, press the **Tab** key repeatedly until the pointer rests on the **touchpad** button. Then press the **spacebar** to select the button.

Touchpad components

Identify the touchpad components.

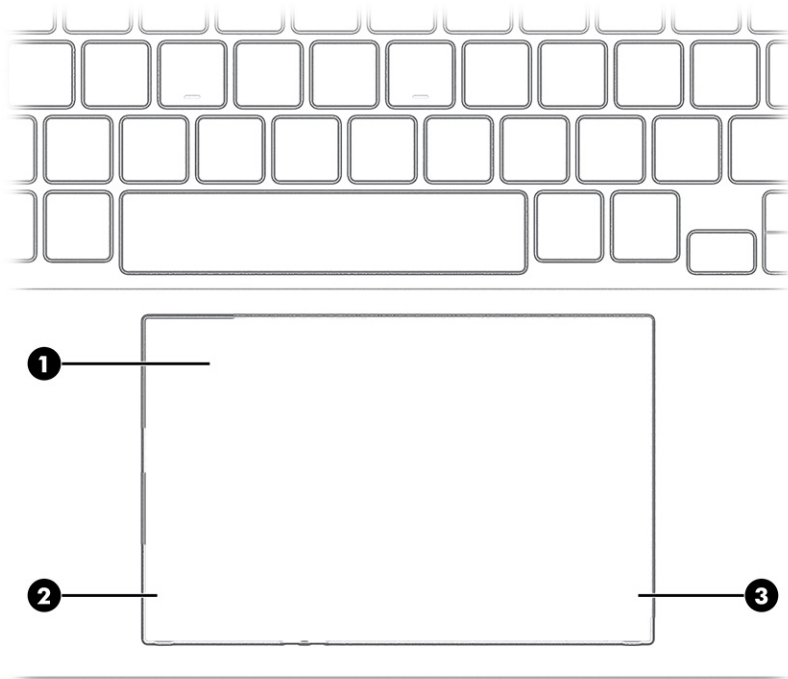

Table 2-4 Touchpad components and their descriptions

Component	Description
(1) Touchpad zone	Reads your finger gestures to move the pointer or activate items on the screen.
(2) Left control zone	Textured area that allows you to perform additional gestures.

Table 2-4 Touchpad components and their descriptions (continued)

Component	Description
(3) Right control zone	Textured area that allows you to perform additional gestures.

Lights

Identify the lights on the computer.

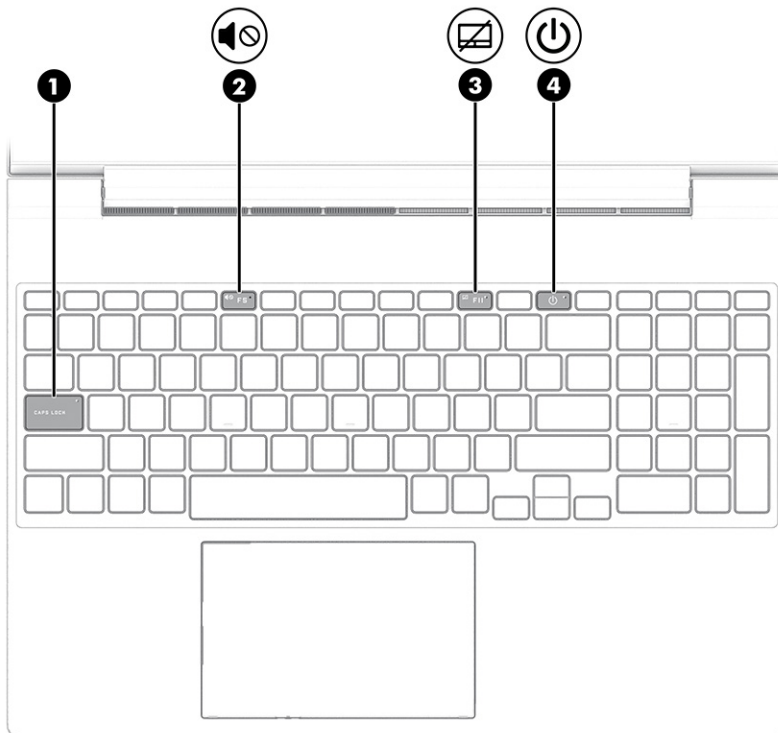

Table 2-5 Lights and their descriptions



Component	Description
(1) Caps lock light	On: Caps lock is on, which switches the key input to all capital letters.
(2)  Mute light	<ul style="list-style-type: none">• On: Computer sound is off.• Off: Computer sound is on.
(3)  Touchpad light	<ul style="list-style-type: none">• On: The touchpad is off.• Off: The touchpad is on.

Table 2-5 Lights and their descriptions (continued)

Component	Description
(4)  Power light	<ul style="list-style-type: none">• On: The computer is on.• Blinking (select products only): The computer is in the Sleep state, a power-saving state. The computer shuts off power to the display and other unnecessary components.• Off: Depending on your computer model, the computer is off, in Hibernation, or in Sleep. Hibernation is the power-saving state that uses the least amount of power.

Button

Identify the computer button.

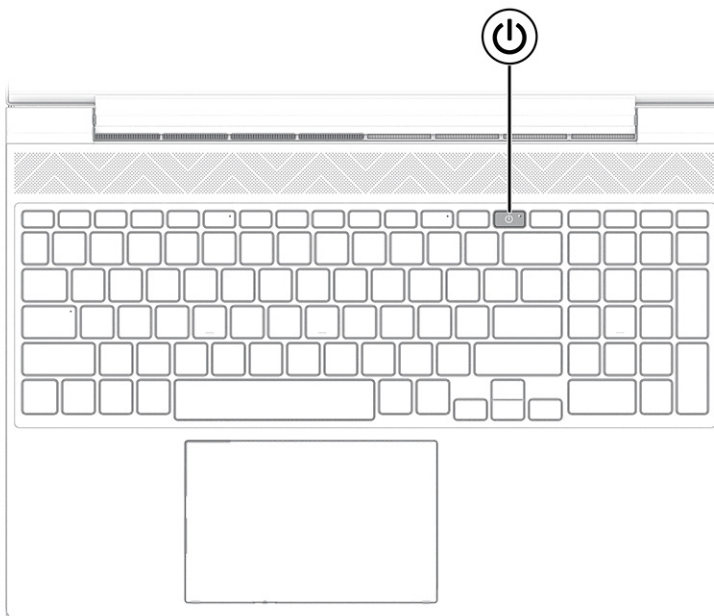



Table 2-6 Button and description

Component	Description
 Power button	<ul style="list-style-type: none"> When the computer is off, press the button briefly to turn on the computer. When the computer is on, press the button briefly to initiate Sleep. When the computer is in the Sleep state, press the button briefly to exit Sleep (select products only). When the computer is in Hibernation, press the button briefly to exit Hibernation. <p>IMPORTANT: Pressing and holding down the power button results in the loss of unsaved information.</p> <p>If the computer has stopped responding and shutdown procedures are ineffective, press and hold the power button down for at least 10 seconds to turn off the computer.</p> <p>To learn more about your power and sleep settings:</p> <ul style="list-style-type: none"> Right-click the Power icon , and then select Power and sleep settings.

Special keys

Identify the special keys.

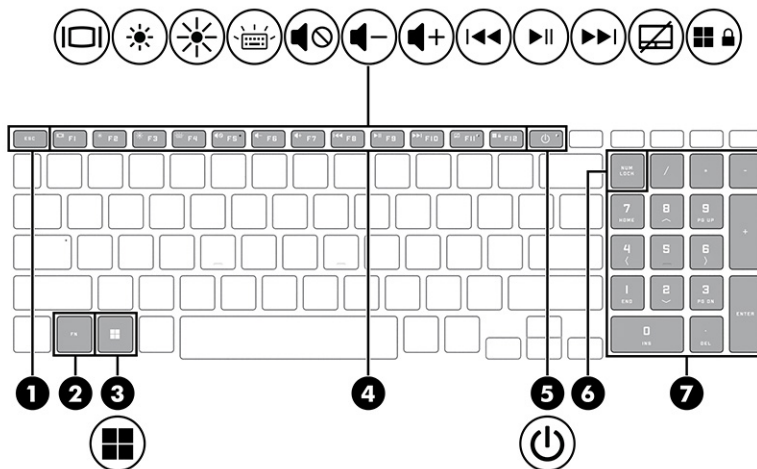

Table 2-7 Special keys and their descriptions

Component	Description
(1) <code>esc</code> key	Displays system information when pressed in combination with the <code>fn</code> key.
(2) <code>fn</code> key	Executes specific functions when pressed in combination with another key.

Table 2-7 Special keys and their descriptions (continued)



Component	Description
(3)  Windows key	Opens the Start menu. NOTE: Pressing the Windows key again will close the Start menu.
(4) Action keys	Execute frequently used system functions as defined by the icon symbols on f1 through f12 function keys.
(5)  Power button	<ul style="list-style-type: none">• When the computer is off, press the button briefly to turn on the computer.• When the computer is on, press the button briefly to initiate Sleep.• When the computer is in the Sleep state, press the button briefly to exit Sleep (select products only).• When the computer is in Hibernation, press the button briefly to exit Hibernation. <p>IMPORTANT: Pressing and holding down the power button results in the loss of unsaved information.</p> <p>If the computer has stopped responding and shutdown procedures are ineffective, press and hold the power button down for at least 10 seconds to turn off the computer.</p> <p>To learn more about your power and sleep settings:</p> <ul style="list-style-type: none">▪ Right-click the Power icon , and then select Power and sleep settings.
(6) num lock key	Alternates between the navigational and numeric functions on the integrated numeric keypad.

Table 2-7 Special keys and their descriptions (continued)

Component	Description
(7) Integrated numeric keypad	<p>A separate keypad to the right of the alphabet keyboard. When num lock is pressed, the keypad can be used like an external numeric keypad.</p> <p>NOTE: If the keypad function is active when the computer is turned off, that function is reinstated when the computer is turned back on.</p>

Bottom

Identify the bottom components.

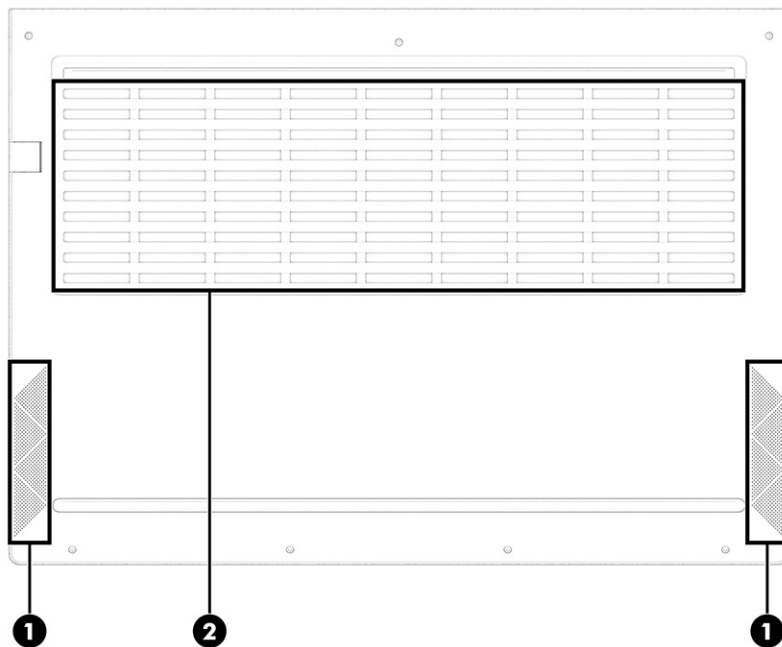

Table 2-8 Bottom components and their descriptions

Component	Description
(1) Speakers (2)	Produce sound.

Table 2-8 Bottom components and their descriptions (continued)

Component	Description
(2) Vent	Enables airflow to cool internal components. NOTE: The computer fan starts up automatically to cool internal components and prevent overheating. It is normal for the internal fan to cycle on and off during routine operation.

Rear

Use the illustration and table to identify the rear component.

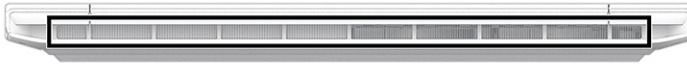



Table 2-9 Rear component and its description

Component	Description
Vent	Enables airflow to cool internal components. NOTE: The computer fan starts up automatically to cool internal components and prevent overheating. It is normal for the internal fan to cycle on and off during routine operation.

Labels

The labels affixed to the computer provide information that you might need when you troubleshoot system problems or travel internationally with the computer. Labels can be in paper form or imprinted on the product.

 **IMPORTANT:** Check the following locations for the labels described in this section: the bottom of the computer, inside the battery bay, under the service door, on the back of the display, or on the bottom of a tablet kickstand.

- Service label—Provides important information to identify your computer. When contacting support, you might be asked for the serial number, the product number, or the model number. Locate this information before you contact support.

Your service label will resemble one of the following examples. Refer to the illustration that most closely matches the service label on your computer.



Table 2-10 Service label components

Component
(1) Serial number
(2) Product ID
(3) HP product name and model number

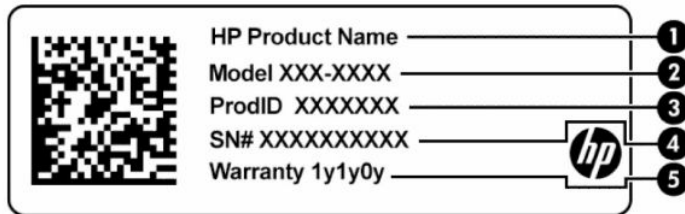

Table 2-11 Service label components

Component
(1) HP product name
(2) Model number
(3) Product ID
(4) Serial number
(5) Warranty period

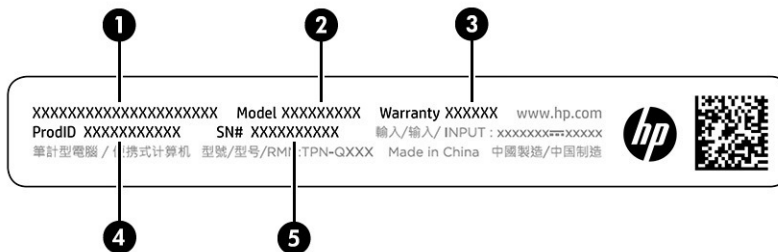

Table 2-12 Service label components

Component
(1) HP product name
(2) Model number
(3) Warranty period
(4) Product ID
(5) Serial number

- Regulatory labels—Provide regulatory information about the computer.
- Wireless certification labels—Provide information about optional wireless devices and the approval markings for the countries or regions in which the devices have been approved for use.

3 Illustrated parts catalog

Use this chapter to determine the spare parts that are available for the computer.

Computer major components

To identify the computer major components, use this illustration and table.

 **NOTE:** HP continually improves and changes product parts. For complete and current information about supported parts for your computer, go to <http://partsurfer.hp.com>, select your country or region, and then follow the on-screen instructions.

 **NOTE:** Details about your computer, including model, serial number, product key, and length of warranty, are on the service tag at the bottom of your computer.

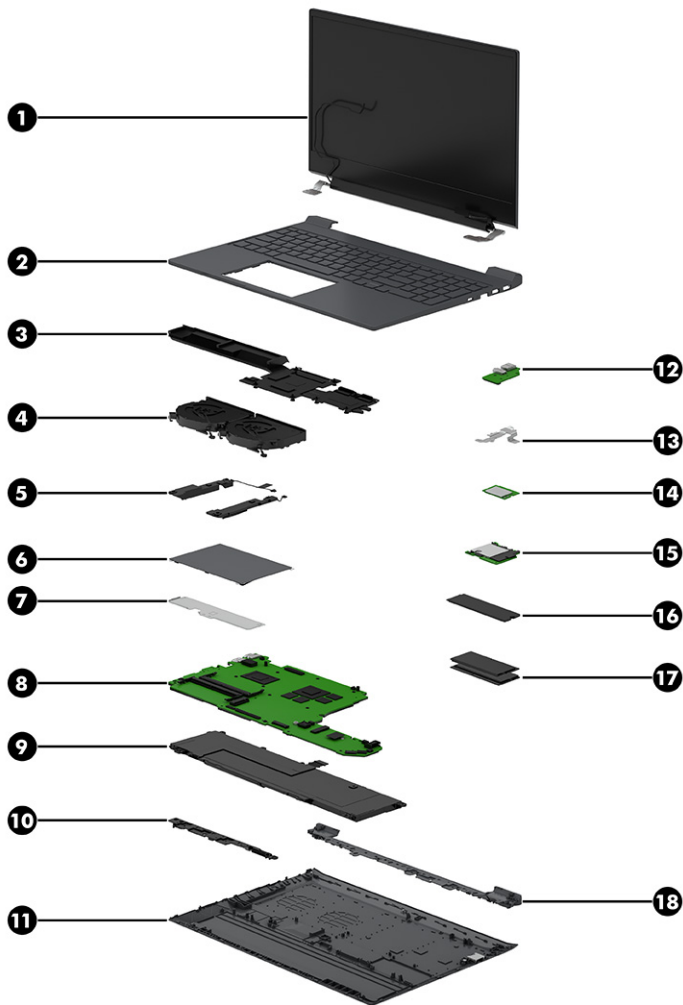

Table 3-1 Computer major component descriptions and part numbers

Item	Component	Spare part number
(1)	Display assembly NOTE: Display spare parts are available only as subcomponents. For spare part information, see Display assembly subcomponents on page 21 .	
(2)	Top cover with keyboard NOTE: For a detailed list of country codes, see Top cover with keyboard on page 64 .	
	Ceramic white	N13297-xx1
	Mica silver	N13298-xx1
	Performance blue	N13299-xx1
(3)	Heat sink assembly	
	For use in models with RTX 3050 or 3050Ti	N13305-001
	For use in models with GTX 1650 graphics	N13306-001
	For use in models with RX 6500M graphics	N14593-001
(4)	Fan assembly	N13304-001
(5)	Speakers	N13315-001
(6)	Touchpad NOTE: The touchpad cable is available as spare part number N13312-001.	
	Ceramic white	N13309-001
	Mica silver	N13310-001
	Performance blue	N13311-001
(7)	Touchpad bracket	not available as a spare part
(8)	System board NOTE: The system board repair kit is available as spare part number N19085-888. All system boards use the following part numbers: xxxxxx-001: Non-Windows operating systems xxxxxx-601: Windows operating system	
	AMD Ryzen7-5800H processor and AMD Radeon RX6500M graphics	N14592-xx1
	AMD Ryzen7-5800H processor and NVIDIA GeForce RTX 3050 graphics	N14588-xx1
	AMD Ryzen7-5800H processor and NVIDIA GeForce RTX 3050 Ti graphics	N14590-xx1
	AMD Ryzen7-5800H processor and NVIDIA GeForce GTX 1650 graphics	N14586-xx1
	AMD Ryzen5-5600H processor and AMD Radeon RX6500M graphics	N14591-xx1
	AMD Ryzen5-5600H processor and NVIDIA GeForce RTX 3050 graphics	N14587-xx1
	AMD Ryzen5-5600H processor and NVIDIA GeForce RTX 3050 Ti graphics	N14589-xx1
	AMD Ryzen5-5600H processor and NVIDIA GeForce GTX 1650 graphics	N14585-xx1
(9)	Battery	

Table 3-1 Computer major component descriptions and part numbers (continued)

Item	Component	Spare part number
	4 cell, 70 Whr for use in models with GeForce RTX 3050 or 3050 Ti graphics	M39179-005
	3 cell, 52 Whr for use in models with GeForce GTX 1650 and GeForce RX 6500M graphics	L84394-005
(10)	Dummy fin	N13308-001
(11)	Bottom cover	
	Ceramic white	N13316-001
	Mica silver	N13317-001
	Performance blue	N13318-001
(12)	I/O board	N13300-001
	NOTE: The I/O board cable is available as spare part number N13301-001.	
(13)	I/O board bracket	not available as a spare part
(14)	WLAN module	
	MediaTek Wi-Fi 6E RZ616 + Bluetooth 5.2	M90511-005
	MediaTek Wi-Fi 6 MT7921 + Bluetooth 5.2	M74879-005
(15)	Card reader	N13302-001
	NOTE: The card reader cable is available as spare part number N13303-001.	
(16)	Solid-state drive (PCIe-3 × 4)	
	1 TB	L85348-005
	512 GB	L85360-005
	256 GB	L85350-005
(17)	Memory module (DDR4-3200)	
	8 GB	L46598-001
	4 GB	L83673-001
(18)	Plastic rear vent	N13307-001
*	Power connector and cable	N13314-001
*	RJ-45 (network) jack door	
	Ceramic white	N13335-001
	Mica silver	N13336-001
	Performance blue	N13337-001

Table 3-1 Computer major component descriptions and part numbers (continued)

Item	Component	Spare part number
	*not illustrated	

Display assembly subcomponents

To identify the display assembly subcomponents, use this illustration and table.

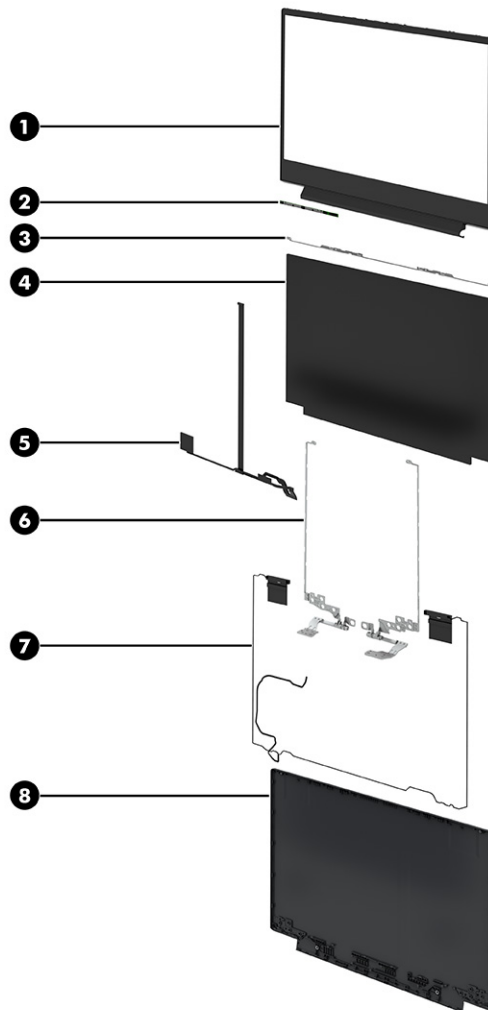

Table 3-2 Display component descriptions and part numbers

Item	Component	Spare part number
(1)	Bezel	N13327-001
(2)	Camera module	N13328-001
(3)	Panel bracket	N13330-001
(4)	Display panel	
	FHD, SVA, 250 nits	N13293-001

Table 3-2 Display component descriptions and part numbers (continued)

Item	Component	Spare part number
	FHD, UWVA, 250 nits	N13294-001
	FHD, UWVA, 250 nits, 144 Hz	N13295-001
	FHD, UWVA, 300 nits	N13296-001
(5)	Display cable	
	Standard models	N13332-001
	144 Hz models	N13331-001
(6)	Display hinges and brackets (includes left and right hinges)	N13329-001
(7)	WLAN antenna kit (includes antenna cables and transceivers)	
	Models with a 300 nit panel	N13325-001
	Models with a 250 nit panel	N13326-001
(8)	Display back cover (includes antennas)	
	Ceramic white models with a 300 nit panel	N13319-001
	Mica silver models with a 300 nit panel	N13320-001
	Performance blue models with a 300 nit panel	N13321-001
	Ceramic white models with a 250 nit panel	N13322-001
	Mica silver models with a 250 nit panel	N13323-001
	Performance blue models with a 250 nit panel	N13324-001
*	Display panel adhesive (includes panel adhesive and bezel adhesive)	N13334-001
	*not illustrated	

Miscellaneous parts

To identify the miscellaneous parts, use this table.

Table 3-3 Miscellaneous part descriptions and part numbers

Component	Spare part number
AC adapter (PFC, Smart, slim, 4.5 mm)	
200 W	L00818-850
150 W	L32661-001
USB External DVD±RW drive	747080-001
HMDI-to-VGA adapter	701943-001
USB-C-to-USB-A hub	916838-001
HP Elite USB-C Multi Port Hub	L39572-001
System board repair kit	N19085-888
Display adhesive kit (includes display cover adhesive and bezel adhesive)	N13334-001

Table 3-3 Miscellaneous part descriptions and part numbers (continued)

Component	Spare part number
Screw Kit	N13333-001
Power cord (C5, 1.0 m [3.3 ft], conventional)	
Argentina	L19357-001
Australia	L19358-001
Denmark	L19360-001
Europe (Austria, Belgium, Finland, France, Germany, the Netherlands, Norway, and Sweden)	L19361-001
Europe (Austria, Belgium, Finland, France, Germany, the Netherlands, Norway, and Sweden) (ADP + cord)	N16170-001
India	L19363-001
Israel	L19362-001
Italy	L19364-001
Japan	L19365-001
North America	L19367-001
People's Republic of China	L19368-001
South Africa	L19369-001
South Korea	L19366-001
Switzerland	L19370-001
Taiwan	L19372-001
Thailand	L19371-001
Thailand (ADP + cord)	M85418-001
The United Kingdom	L19373-001
Power cord (C13, 1.0 m [3.3 ft], conventional)	
Argentina	L22104-001
Australia	L22339-001
Denmark	L22334-001
Europe (Austria, Belgium, Finland, France, Germany, the Netherlands, Norway, and Sweden)	L22333-001
India	L22343-001
Italy/Chile	L22103-001
Israel	L22335-001
Japan	L22344-001
North America	L22331-001
People's Republic of China	L22341-001
South Africa	L22337-001
South Korea	L22340-001
Switzerland	L22336-001

Table 3-3 Miscellaneous part descriptions and part numbers (continued)

Component	Spare part number
Taiwan	L22342-001
Thailand	L22338-001
Thailand (ADP + cord)	M85413-001
The United Kingdom	L22332-001

4 Removal and replacement procedures preliminary requirements

Use this information to properly prepare to disassemble and reassemble the computer.

Tools required

You need the following tools to complete the removal and replacement procedures:

- Tweezers
- Nonconductive, nonmarking pry tool
- Magnetic Phillips P1 screwdriver

Service considerations

The following sections include some of the considerations that you must keep in mind during disassembly and assembly procedures.

 **NOTE:** As you remove each subassembly from the computer, place the subassembly (and all accompanying screws) away from the work area to prevent damage.

Plastic parts

Using excessive force during disassembly and reassembly can damage plastic parts.

Cables and connectors

Handle cables with extreme care to avoid damage.

 **IMPORTANT:** When servicing the computer, be sure that cables are placed in their proper locations during the reassembly process. Improper cable placement can damage the computer.

Apply only the tension required to unseat or seat the cables during removal and insertion. Handle cables by the connector whenever possible. In all cases, avoid bending, twisting, or tearing cables. Be sure that cables are routed so that they cannot be caught or snagged as you remove or replace parts. Handle flex cables with extreme care; these cables tear easily.

Drive handling

Note the following guidelines when handling drives.

 **IMPORTANT:** Drives are fragile components. Handle them with care. To prevent damage to the computer, damage to a drive, or loss of information, observe these precautions:

Before removing or inserting a hard drive, shut down the computer. If you are unsure whether the computer is off or in Hibernation, turn the computer on, and then shut it down through the operating system.

Before handling a drive, be sure that you are discharged of static electricity. While handling a drive, avoid touching the connector.

Before removing an optical drive, be sure that a disc is not in the drive, and be sure that the optical drive tray is closed.

Handle drives on surfaces covered with at least 2.54 cm (1 inch) of shock-proof foam.

Avoid dropping drives from any height onto any surface.

After removing a hard drive or an optical drive, place it in a static-proof bag.

Avoid exposing an internal hard drive to products that have magnetic fields, such as monitors or speakers.

Avoid exposing a drive to temperature extremes or liquids.

If a drive must be mailed, place the drive in a bubble pack mailer or other suitable form of protective packaging, and label the package "FRAGILE."

Electrostatic discharge information

A sudden discharge of static electricity from your finger or other conductor can destroy static-sensitive devices or microcircuitry. Often the spark is neither felt nor heard, but damage occurs. An electronic device exposed to electrostatic discharge (ESD) might not appear to be affected at all and can work perfectly throughout a normal cycle. The device might function normally for a while, but it has been degraded in the internal layers, reducing its life expectancy.

Networks built into many integrated circuits provide some protection, but in many cases, the discharge contains enough power to alter device parameters or melt silicon junctions.

 **IMPORTANT:** To prevent damage to the device when you remove or install internal components, observe these precautions:

Keep components in their electrostatic-safe containers until you are ready to install them.

Before touching an electronic component, discharge static electricity by using the guidelines described [Personal grounding methods and equipment on page 27](#).

Avoid touching pins, leads, and circuitry. Handle electronic components as little as possible.

If you remove a component, place it in an electrostatic-safe container.

Generating static electricity

Follow these static electricity guidelines.

- Different activities generate different amounts of static electricity.
- Static electricity increases as humidity decreases.

Table 4-1 Static electricity occurrence based on activity and humidity

Event	Relative humidity		
	55%	40%	10%
Walking across carpet	7,500 V	15,000 V	35,000 V
Walking across vinyl floor	3,000 V	5,000 V	12,000 V
Motions of bench worker	400 V	800 V	6,000 V
Removing DIPs (dual in-line packages) from plastic tube	400 V	700 V	2,000 V
Removing DIPs from vinyl tray	2,000 V	4,000 V	11,500 V
Removing DIPs from polystyrene foam	3,500 V	5,000 V	14,500 V
Removing bubble pack from PCB (printed circuit board)	7,000 V	20,000 V	26,500 V
Packing PCBs in foam-lined box	5,000 V	11,000 V	21,000 V
Multiple electric components can be packaged together in plastic tubes, trays, or polystyrene foam.			

 **NOTE:** As little as 700 V can degrade a product.

Preventing electrostatic damage to equipment

Many electronic components are sensitive to ESD. Circuitry design and structure determine the degree of sensitivity. The following packaging and grounding precautions are necessary to prevent static electricity damage to electronic components.

- To avoid hand contact, transport products in static-safe containers such as tubes, bags, or boxes.
- Protect all electrostatic parts and assemblies with conductive or approved containers or packaging.
- Keep electrostatic-sensitive parts in their containers until they arrive at static-free stations.
- Place items on a grounded surface before removing them from their container.
- Always be properly grounded when touching a sensitive component or assembly.
- Avoid contact with pins, leads, or circuitry.
- Place reusable electrostatic-sensitive parts from assemblies in protective packaging or conductive foam.

Personal grounding methods and equipment

Using certain equipment can prevent static electricity damage to electronic components.

- **Wrist straps** are flexible straps with a maximum of $1\text{ M}\Omega \pm 10\%$ resistance in the ground cords. To provide proper ground, a strap must be worn snug against bare skin. The ground cord must be connected and fit snugly into the banana plug connector on the grounding mat or workstation.
- **Heel straps/Toe straps/Boot straps** can be used at standing workstations and are compatible with most types of shoes or boots. On conductive floors or dissipative floor mats, use them on both feet with a maximum of $1\text{ M}\Omega \pm 10\%$ resistance between the operator and ground.

Table 4-2 Static shielding protection levels

Static shielding protection levels	
Method	Voltage
Antistatic plastic	1,500
Carbon-loaded plastic	7,500
Metallized laminate	15,000

Grounding the work area

To prevent static damage at the work area, follow these precautions.

- Cover the work surface with approved static-dissipative material.
- Use a wrist strap connected to a properly grounded work surface and use properly grounded tools and equipment.
- Use static-dissipative mats, foot straps, or air ionizers to give added protection.
- Handle electrostatic sensitive components, parts, and assemblies by the case or PCB laminate. Handle them only at static-free work areas.
- Turn off power and input signals before inserting and removing connectors or test equipment.
- Use fixtures made of static-safe materials when fixtures must directly contact dissipative surfaces.
- Keep the work area free of nonconductive materials, such as ordinary plastic assembly aids and polystyrene foam.
- Use conductive field service tools, such as cutters, screwdrivers, and vacuums.
- Avoid contact with pins, leads, or circuitry.

Recommended materials and equipment

HP recommends certain materials and equipment to prevent static electricity.

- Antistatic tape
- Antistatic smocks, aprons, or sleeve protectors
- Conductive bins and other assembly or soldering aids
- Conductive foam
- Conductive tabletop workstations with ground cord of $1\text{ M}\Omega \pm 10\%$ resistance
- Static-dissipative table or floor mats with hard tie to ground
- Field service kits
- Static awareness labels
- Wrist straps and footwear straps providing $1\text{ M}\Omega \pm 10\%$ resistance
- Material handling packages

- Conductive plastic bags
- Conductive plastic tubes
- Conductive tote boxes
- Opaque shielding bags
- Transparent metallized shielding bags
- Transparent shielding tubes

Cleaning your computer

Cleaning your computer regularly removes dirt and debris so that your device continues to operate at its best. Use the following information to safely clean the external surfaces of your computer.

Enabling HP Easy Clean (select products only)

HP Easy Clean helps you to avoid accidental input while you clean the computer surfaces. This software disables devices such as the keyboard, touch screen, and touchpad for a preset amount of time so that you can clean all computer surfaces.

1. Start HP Easy Clean in one of the following ways:
 - Select the **Start** menu, and then select **HP Easy Clean**.
– or –
 - Select the **HP Easy Clean** icon in the taskbar.
– or –
 - Select **Start**, and then select the **HP Easy Clean** tile.
2. Now that your device is disabled for a short period, see [Removing dirt and debris from your computer on page 29](#) for the recommended steps to clean the high-touch, external surfaces on your computer. After you remove the dirt and debris, you can also clean the surfaces with a disinfectant. See [Cleaning your computer with a disinfectant on page 30](#) for guidelines to help prevent the spread of harmful bacteria and viruses.

Removing dirt and debris from your computer

Here are the recommended steps to clean dirt and debris from your computer.

For computers with wood veneer, see [Caring for wood veneer \(select products only\) on page 31](#).

1. Wear disposable gloves made of latex (or nitrile gloves, if you are latex-sensitive) when cleaning the surfaces.
2. Turn off your device and unplug the power cord and other connected external devices. Remove any installed batteries from items such as wireless keyboards.

 **CAUTION:** To prevent electric shock or damage to components, never clean a product while it is turned on or plugged in.

3. Moisten a microfiber cloth with water. The cloth should be moist, but not dripping wet.

 **IMPORTANT:** To avoid damaging the surface, avoid abrasive cloths, towels, and paper towels.

4. Wipe the exterior of the product gently with the moistened cloth.

 **IMPORTANT:** Keep liquids away from the product. Avoid getting moisture in any openings. If liquid makes its way inside your HP product, it can cause damage to the product. Do not spray liquids directly on the product. Do not use aerosol sprays, solvents, abrasives, or cleaners containing hydrogen peroxide or bleach that might damage the finish.

5. Start with the display (if applicable). Wipe carefully in one direction, and move from the top of the display to the bottom. Finish with any flexible cables, like power cord, keyboard cable, and USB cables.
6. Be sure that surfaces have completely air-dried before turning the device on after cleaning.
7. Discard the gloves after each cleaning. Clean your hands immediately after you remove the gloves.

See [Cleaning your computer with a disinfectant on page 30](#) for recommended steps to clean the high-touch, external surfaces on your computer to help prevent the spread of harmful bacteria and viruses.

Cleaning your computer with a disinfectant

The World Health Organization (WHO) recommends cleaning surfaces, followed by disinfection, as a best practice for preventing the spread of viral respiratory illnesses and harmful bacteria.

After cleaning the external surfaces of your computer using the steps in [Removing dirt and debris from your computer on page 29](#), [Caring for wood veneer \(select products only\) on page 31](#), or both, you might also choose to clean the surfaces with a disinfectant. A disinfectant that is within HP's cleaning guidelines is an alcohol solution consisting of 70% isopropyl alcohol and 30% water. This solution is also known as rubbing alcohol and is sold in most stores.

Follow these steps when disinfecting high-touch, external surfaces on your computer:

1. Wear disposable gloves made of latex (or nitrile gloves, if you are latex-sensitive) when cleaning the surfaces.
2. Turn off your device and unplug the power cord and other connected external devices. Remove any installed batteries from items such as wireless keyboards.

 **CAUTION:** To prevent electric shock or damage to components, never clean a product while it is turned on or plugged in.

3. Moisten a microfiber cloth with a mixture of 70% isopropyl alcohol and 30% water. The cloth should be moist, but not dripping wet.

 **CAUTION:** Do not use any of the following chemicals or any solutions that contain them, including spray-based surface cleaners: bleach, peroxides (including hydrogen peroxide), acetone, ammonia, ethyl alcohol, methylene chloride, or any petroleum-based materials, such as gasoline, paint thinner, benzene, or toluene.

 **IMPORTANT:** To avoid damaging the surface, avoid abrasive cloths, towels, and paper towels.

4. Wipe the exterior of the product gently with the moistened cloth.

 **IMPORTANT:** Keep liquids away from the product. Avoid getting moisture in any openings. If liquid makes its way inside your HP product, it can cause damage to the product. Do not spray liquids directly

on the product. Do not use aerosol sprays, solvents, abrasives, or cleaners containing hydrogen peroxide or bleach that might damage the finish.

5. Start with the display (if applicable). Wipe carefully in one direction, and move from the top of the display to the bottom. Finish with any flexible cables, like power cord, keyboard cable, and USB cables.
6. Be sure that surfaces have completely air-dried before turning the device on after cleaning.
7. Discard the gloves after each cleaning. Clean your hands immediately after you remove the gloves.

Caring for wood veneer (select products only)

Your product might feature high-quality wood veneer. As with all natural wood products, proper care is important for best results over the life of the product. Because of the nature of natural wood, you might see unique variations in the grain pattern or subtle variations in color, which are normal.

- Clean the wood with a dry, static-free microfiber cloth or chamois.
- Avoid cleaning products containing substances such as ammonia, methylene chloride, acetone, turpentine, or other petroleum-based solvents.
- Do not expose the wood to sun or moisture for long periods of time.
- If the wood becomes wet, dry it by dabbing with an absorbent, lint-free cloth.
- Avoid contact with any substance that might dye or discolor the wood.
- Avoid contact with sharp objects or rough surfaces that might scratch the wood.

See [Removing dirt and debris from your computer on page 29](#) for the recommended steps to clean the high-touch, external surfaces on your computer. After you remove the dirt and debris, you can also clean the surfaces with a disinfectant. See [Cleaning your computer with a disinfectant on page 30](#) for sanitizing guidelines to help prevent the spread of harmful bacteria and viruses.

Packaging and transporting guidelines

Follow these grounding guidelines when packaging and transporting equipment.

- To avoid hand contact, transport products in static-safe tubes, bags, or boxes.
- Protect ESD-sensitive parts and assemblies with conductive or approved containers or packaging.
- Keep ESD-sensitive parts in their containers until the parts arrive at static-free workstations.
- Place items on a grounded surface before removing items from their containers.
- Always be properly grounded when touching a component or assembly.
- Store reusable ESD-sensitive parts from assemblies in protective packaging or nonconductive foam.

- Use transporters and conveyors made of antistatic belts and roller bushings. Be sure that mechanized equipment used for moving materials is wired to ground and that proper materials are selected to avoid static charging. When grounding is not possible, use an ionizer to dissipate electric charges.

Accessing support information

To find the HP support that you need, use this information.

Table 4-3 Support information locations



Service consideration	Path to access information
Records of reported failure incidents stored on the computer	<p>Windows:</p> <p>Pre-operating system failures are logged in the BIOS Event Log. To view the BIOS Event Log:</p> <ol style="list-style-type: none"> 1. Press the power button. 2. Immediately and repeatedly press esc when the power button light turns white. <p>NOTE: If you do not press esc at the appropriate time, you must restart the computer and again repeatedly press esc when the power button light turns white to access the utility.</p> 3. Press f10 to enter the BIOS setup. 4. (On commercial products) Under the Main tab, select BIOS event log, and then select View BIOS Event Log. <p>- or -</p> <p>(On consumer products) Under the Main tab, select System Log.</p> <p>Post-operating system failures are logged in the Event Viewer.</p> <ol style="list-style-type: none"> 1. Turn on the computer and allow the operating system to open. 2. Select the search icon  in the taskbar. 3. Type <code>Event Viewer</code>, and then press enter. 4. Select the log from the left panel. Details display in the right panel. <p>Chrome:</p> <ol style="list-style-type: none"> 1. Go to support.google.com/chrome. 2. Search <code>collect Chrome device logs</code>.
Technical bulletins	<p>To locate technical bulletins:</p> <ol style="list-style-type: none"> 1. Go to www.hp.com. 2. Place the cursor over Problem solving to display more options. 3. Select Support & Troubleshooting. 4. Type the serial number, product number, or product name to go to the product support page. 5. Select Advisories to view technical bulletins.

Table 4-3 Support information locations (continued)

Service consideration	Path to access information
Repair professionals	To locate repair professionals: <ol style="list-style-type: none">1. Go to www.hp.com.2. Place the cursor over Support resources to display more options.3. Select Authorized service providers.
Component and diagnosis information, failure detection, and required action	To locate diagnosis information and actions: <ol style="list-style-type: none">1. Go to http://www.hp.com/go/techcenter/pcdiags.2. Select Get Support.3. Near the bottom of the window, select Notebook PCs, and then select your location.

5 Removal and replacement procedures for Customer Self-Repair parts

This chapter provides removal and replacement procedures for Customer Self-Repair parts.

 **NOTE:** The Customer Self-Repair program is not available in all locations. Installing a part that is not supported by the Customer Self-Repair program can void your warranty. Check your warranty to determine whether Customer Self-Repair is supported in your location.

Component replacement procedures

To remove and replace computer components, use these procedures.

 **NOTE:** Details about your computer, including model, serial number, product key, and length of warranty, are on the service tag at the bottom of your computer.

 **NOTE:** HP continually improves and changes product parts. For complete and current information about supported parts for your computer, go to <http://partsurfer.hp.com>, select your country or region, and then follow the on-screen instructions.

Make special note of each screw size and location during removal and replacement.

Preparation for disassembly

To prepare to disassemble the computer, use these steps.

See [Removal and replacement procedures preliminary requirements on page 25](#) for initial safety procedures.

1. Turn off the computer. If you are unsure whether the computer is off or in Hibernation, turn the computer on, and then shut it down through the operating system.
2. Disconnect the power from the computer by unplugging the power cord from the computer.
3. Disconnect all external devices from the computer.

Solid-state drive

To remove the solid-state drive, use this procedure and illustration.

Table 5-1 Solid-state drive descriptions and part numbers

Description	Spare part number
1 TB	L85348-005
512 GB	L85360-005
256 GB	L85350-005

Before removing the solid-state drive, follow these steps:

1. Prepare the computer for disassembly (see [Preparation for disassembly on page 34](#)).
2. Remove the bottom cover (see [Bottom cover on page 38](#)).
3. Disconnect the battery cable from the system board (see [Battery on page 40](#)).

Remove the solid-state drive:

1. Remove the Phillips M2.0 × 2.5 screw (1) that secures the drive.
2. Pull the drive away from the socket to remove it (2).

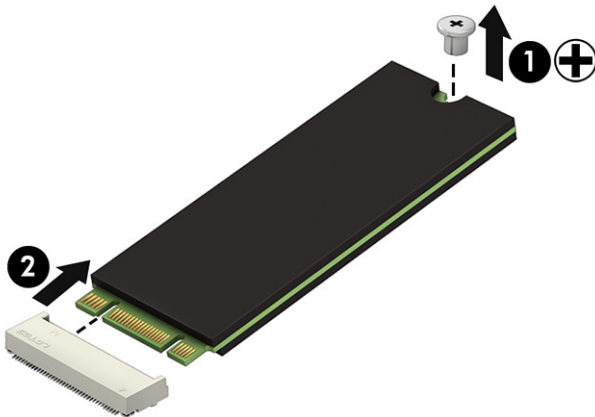

3. When installing a drive, be sure a thermal pad is installed on the top of the drive.

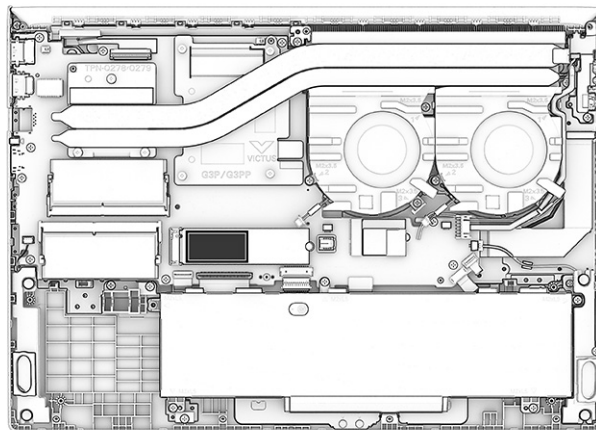

To install a solid-state drive, reverse the removal procedures.

 **NOTE:** Solid-state drives are designed with a notch to prevent incorrect insertion.

Memory modules

To remove the memory modules, use this procedure and illustration.

Table 5-2 Memory module descriptions and part numbers

Description	Spare part number
8 GB, DDR4-3200	L46598-001
4 GB, DDR4-3200	L83673-001

Before removing the memory, follow these steps:

1. Prepare the computer for disassembly (see [Preparation for disassembly on page 34](#)).
2. Remove the bottom cover (see [Bottom cover on page 38](#)).
3. Disconnect the battery cable from the system board (see [Battery on page 40](#)).

If you are replacing a memory module, remove the existing memory module:

1. If present, pull the protective shielding up from the top and toward you to access the memory modules.
2. Spread the two retention clips outward (1) until the memory module tilts up at a 45° angle, and then remove the module (2). Use the same procedure to remove all memory modules.

 **IMPORTANT:** To prevent damage to the memory module, hold the memory module by the edges only. Do not touch the components on the memory module.

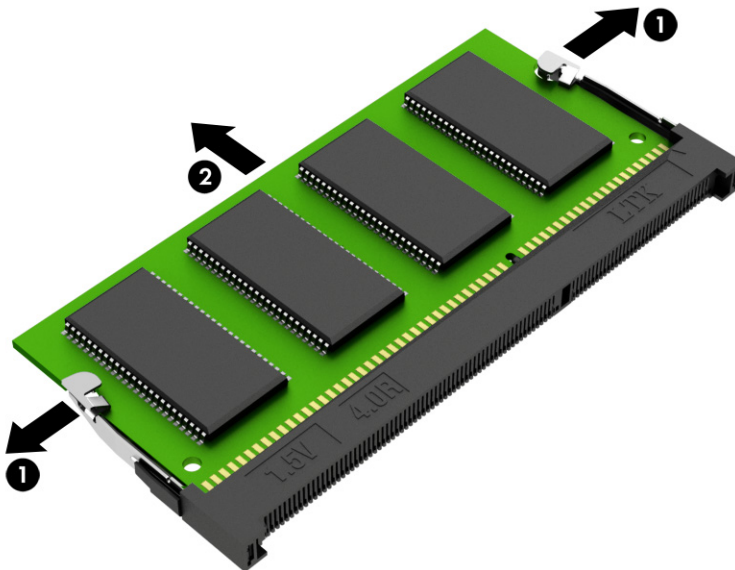

To protect a memory module after removal, place it in an electrostatic-safe container.

To install a memory module:

1. Align the notched edge of the module with the tab in the slot (1), and then press the module into the slot at an angle until it is seated (2).
2. Press down on the module until the side retention clips snap into place (3).

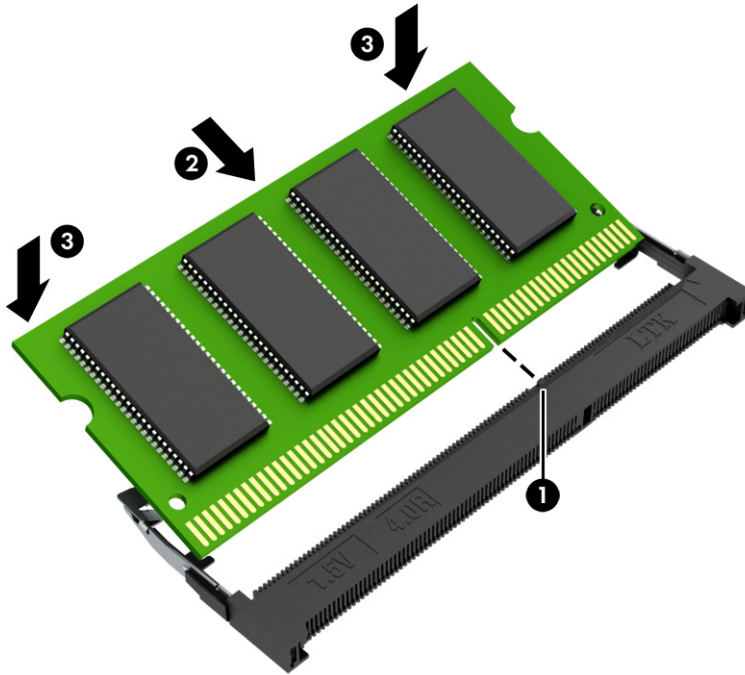

6 Removal and replacement procedures for authorized service provider parts

This chapter provides removal and replacement procedures for authorized service provider parts.

 **IMPORTANT:** Components described in this chapter should be accessed only by an authorized service provider. Accessing these parts can damage the computer or void the warranty.

 **NOTE:** Details about your computer, including model, serial number, product key, and length of warranty, are on the service tag at the bottom of your computer.

Component replacement procedures

To remove and replace computer components, use these procedures.

 **NOTE:** HP continually improves and changes product parts. For complete and current information about supported parts for your computer, go to <http://partsurfer.hp.com>, select your country or region, and then follow the on-screen instructions.

Make special note of each screw size and location during removal and replacement.

Preparation for disassembly

To remove and replace computer components, use these procedures.

See [Removal and replacement procedures preliminary requirements on page 25](#) for initial safety procedures.

1. Turn off the computer. If you are unsure whether the computer is off or in Hibernation, turn the computer on, and then shut it down through the operating system.
2. Disconnect the power from the computer by unplugging the power cord from the computer.
3. Disconnect all external devices from the computer.

Bottom cover

To remove the bottom cover, use this procedure and illustration.

Table 6-1 Bottom cover description and part number

Description	Spare part number
Bottom cover for use in ceramic white models	N13316-001
Bottom cover for use in mica silver models	N13317-001
Bottom cover for use in performance blue models	N13318-001

Before removing the bottom cover, prepare the computer for disassembly (see [Preparation for disassembly on page 38](#)).

Remove the bottom cover:

1. Close the computer and rest it upside down on a flat work surface with the front toward you.
2. Remove the seven Phillips M2.0 × 5.0 screws (1) that secure the bottom cover to the computer.

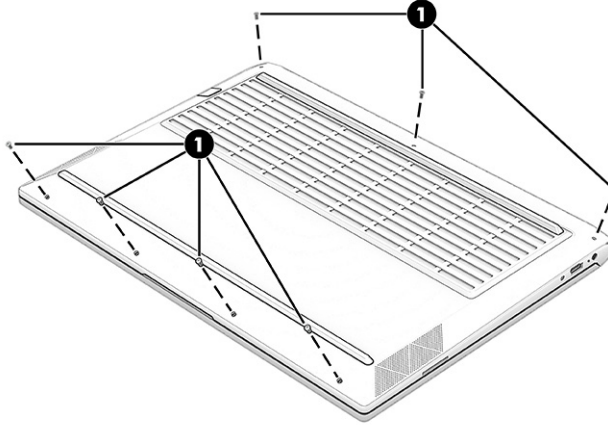

3. In one of the bottom corners, insert a thin, plastic tool in the seam between the bottom cover and computer (1) to release the cover.
4. Remove the bottom cover (2).

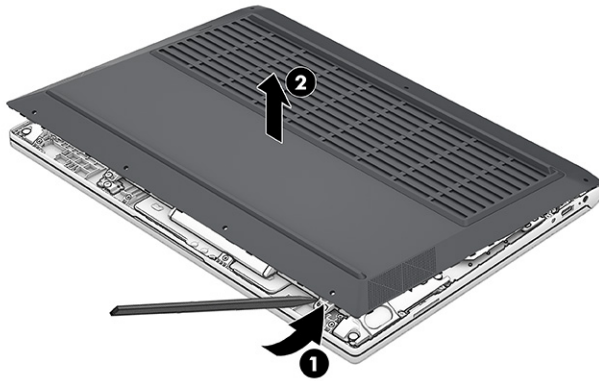

To replace the bottom cover, reverse the removal procedures.

When installing a bottom cover, make sure the thermal pad is installed as shown in the following illustration.

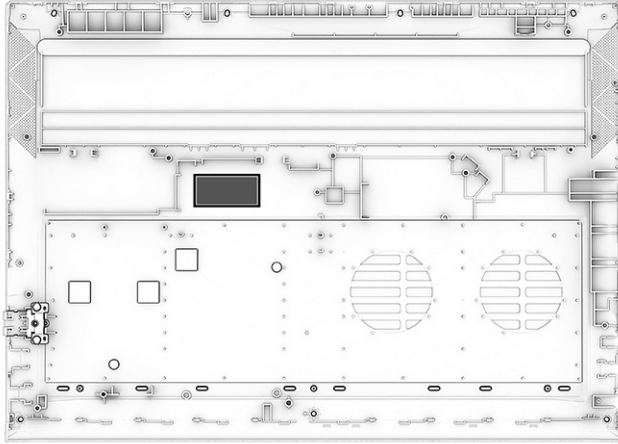

Battery

To remove the battery, use this procedure and illustration.

Table 6-2 Battery description and part number

Description	Spare part number
4 cell, 70 Whr battery for use in models with GeForce RTX 3050 or 3050 Ti graphics	M39179-005
IMPORTANT: The connector pin assignments differ between batteries. To avoid damage to the system board, be sure to use the correct battery based on the graphics used in the computer.	
3 cell, 52.5 Whr battery for use in models with GeForce GTX 1650 graphics	L84394-005

⚠ WARNING! To avoid personal injury and damage to the product:

- Do *not* puncture, twist, or crack the battery.
- Do *not* cause an external puncture or rupture to the battery, which can cause a short inside the battery, which can result in battery thermal runaway.
- Do *not* handle or touch the battery enclosure with sharp objects such as tweezers or pliers, which might puncture the battery.
- Do *not* compress or squeeze the battery case with tools or heavy objects stacked on top of the case. These actions can apply undue force on the battery.
- Do *not* touch the connectors with any metallic surface or object, such as metal tools, screws, or coins, which can cause shorting across the connectors.

Before removing the battery, follow these steps:

1. Prepare the computer for disassembly (see [Preparation for disassembly on page 38](#)).
2. Remove the bottom cover (see [Bottom cover on page 38](#)).

⚠ WARNING! To reduce potential safety issues, use only the user-replaceable battery provided with the computer, a replacement battery provided by HP, or a compatible battery purchased from HP.

📝 IMPORTANT: Removing a battery that is the sole power source for the computer can cause loss of information. To prevent loss of information, save your work or shut down the computer through Windows before you remove the battery.

Remove the battery:

1. Disconnect the battery cable **(1)** from the system board.
2. Remove the six Phillips M2.0 × 5.0 screws **(2)** that secure the battery to the computer.
3. Remove the battery **(3)**.

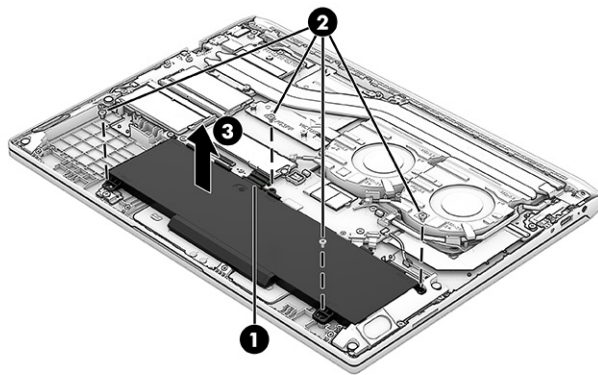

To install the battery, reverse the removal procedures.

Display subcomponents (without removing the display)

You can remove some display subcomponents without removing the entire display assembly from the computer. To remove the bezel, display panel, and camera module, use these procedures and illustrations.

Before removing the display subcomponents, follow these steps:

1. Prepare the computer for disassembly (see [Preparation for disassembly on page 38](#)).
2. Remove the bottom cover (see [Bottom cover on page 38](#)).
3. Disconnect the battery cable from the system board (see [Battery on page 40](#)).

Remove the display assembly:

1. You can remove the bezel with the display assembly connected to the computer. To remove the bezel:
 - a. Flex the top **(1)**, the left and right sides **(2)**, and then the bottom of the bezel **(3)** to release it.
 - b. Remove the bezel from the display **(4)**.

📝 NOTE: The display assembly remains attached to the computer for these procedures.

The display bezel is available as spare part number N13327-001.

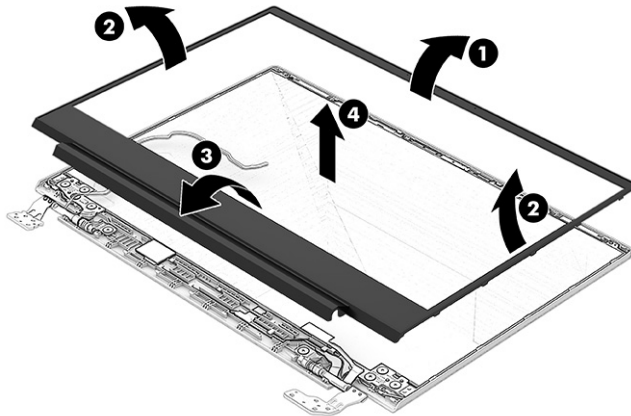

2. You can remove the display panel with the display assembly connected to the computer. To remove the display panel:
 - a. At the top of the panel, use tweezers to grasp the end of the retention tape that is installed under the panel in three locations.
 - b. While turning the tweezers (1), wrap the tape around the tweezers as you continue to pull the tape (2) out from behind the display panel.
 - c. Rotate the panel up and set it next to the display back cover (3).

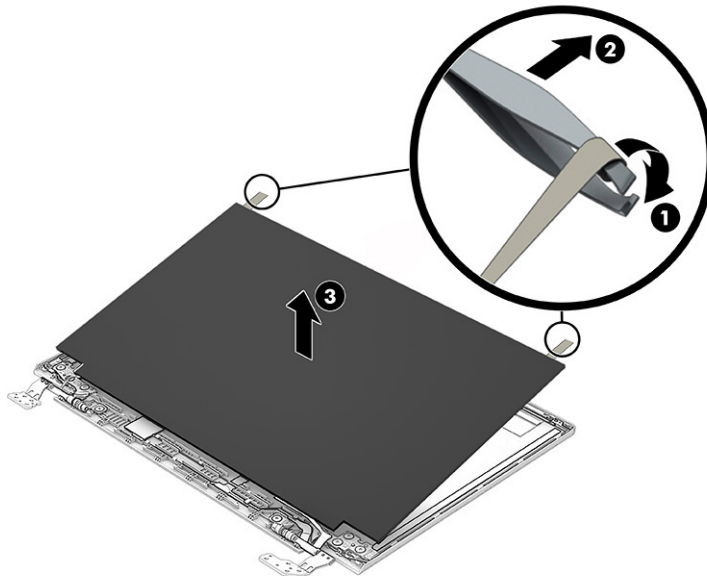

- d. To disconnect the cable from the display panel, lift the tape from the connector on the panel (1), and then disconnect the cable (2).

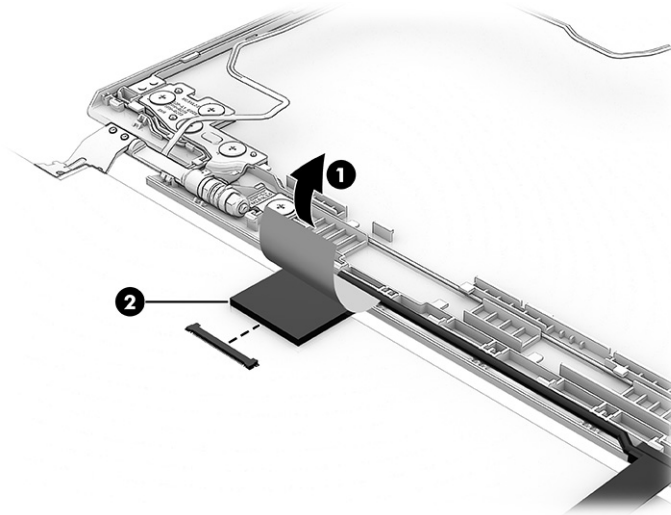

- e. When installing the display panel, install the adhesive strips on each side of the display back cover as shown in the following illustration.

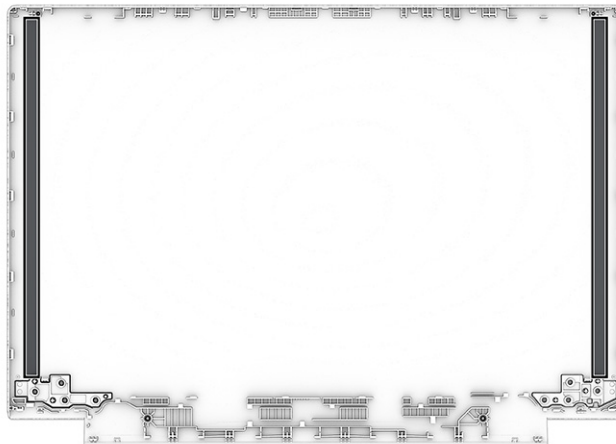

Display panels are available as the following spare part numbers:

N13293-001: FHD, SVA, 250 nits

N13294-001: FHD, UWVA, 250 nits

N13295-001: FHD, UWVA, 250 nits, 144 Hz

N13296-001: FHD, UWVA, 300 nits

The panel adhesive kit is available as spare part number N13334-001.

3. You can remove the camera module with the display assembly connected to the computer. To remove the camera module:

- a. Remove the two Phillips 1.6 × 2.5 screws (1) that secure the top bracket, lift up the hinge brackets slightly (2), and then pull the top bracket out from under the hinge brackets to remove it (3). The top bracket is available as spare part number N13330-001.

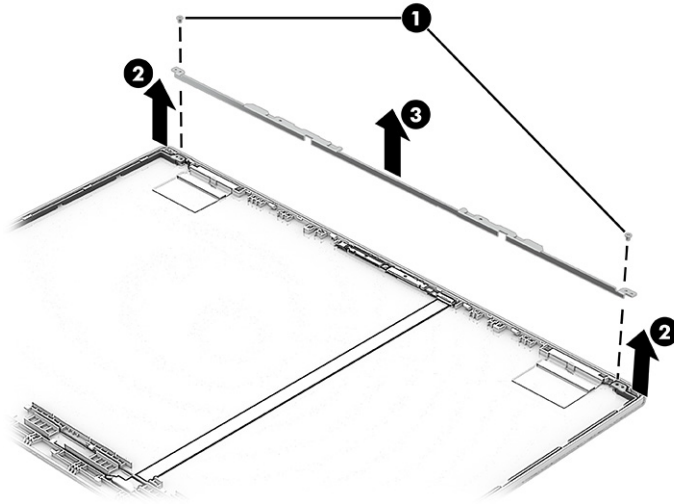

- b. Use a tool to lift up evenly across the module and peel the module up from the display back cover (1), and then disconnect the cable from the reverse ZIF connector on the module (2). The camera module is available as spare part number N13328-001.



NOTE: For installation, note that the cable routes under the camera module before it connects to the module.

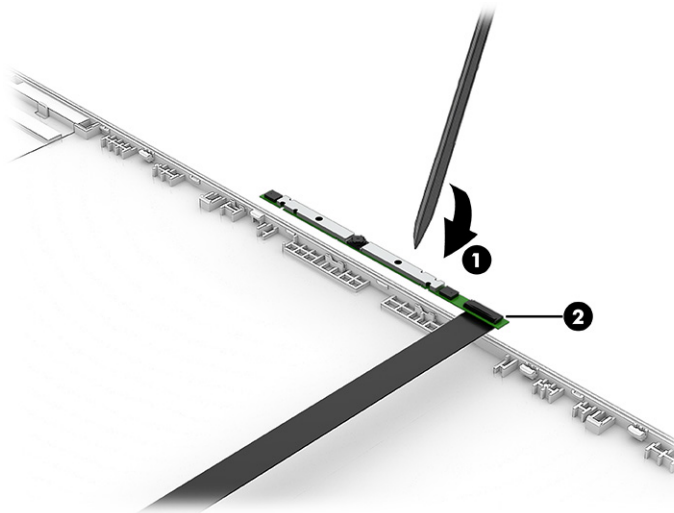

To install the camera and display panel, reverse these procedures.

WLAN module

To remove the WLAN module, use this procedure and illustration.

Table 6-3 WLAN module descriptions and part numbers

Description	Spare part number
MediaTek Wi-Fi 6E RZ616 + Bluetooth 5.2	M90511-005
MediaTek Wi-Fi 6 MT7921 + Bluetooth 5.2	M74879-005

IMPORTANT: To prevent an unresponsive system, replace the wireless module only with a wireless module authorized for use in the computer by the governmental agency that regulates wireless devices in your country or region. If you replace the module and then receive a warning message, remove the module to restore device functionality, and then contact technical support.

Before removing the WLAN module, follow these steps:

1. Prepare the computer for disassembly (see [Preparation for disassembly on page 38](#)).
2. Remove the bottom cover (see [Bottom cover on page 38](#)).
3. Disconnect the battery cable from the system board (see [Battery on page 40](#)).

Remove the WLAN module:

1. Remove the plastic that covers the antennas (1).
2. Remove the Phillips M2.0 × 2.5 screw (2).
3. Carefully disconnect the two antenna cables from the module (3), and then pull the module out of the socket to remove it (4).

NOTE: When installing a WLAN module, be sure to match the numbers on the antenna cables with the numbers next to the connectors on the module.

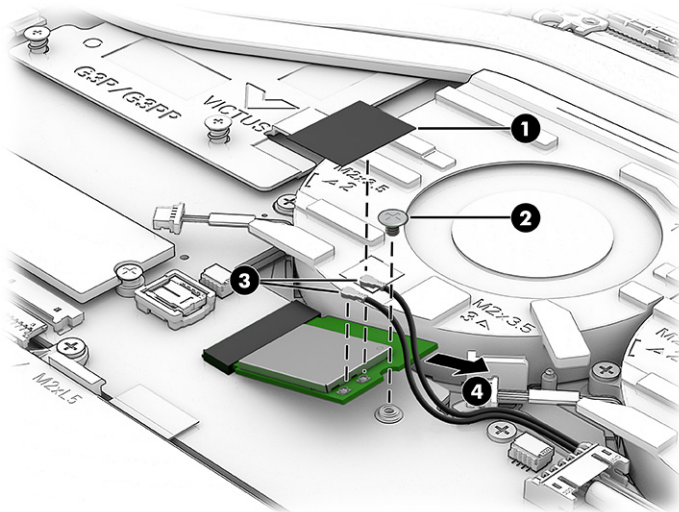

4. If the WLAN antenna is not connected to the terminal on the WLAN module, install a protective sleeve on the antenna connector, as shown in the following illustration.

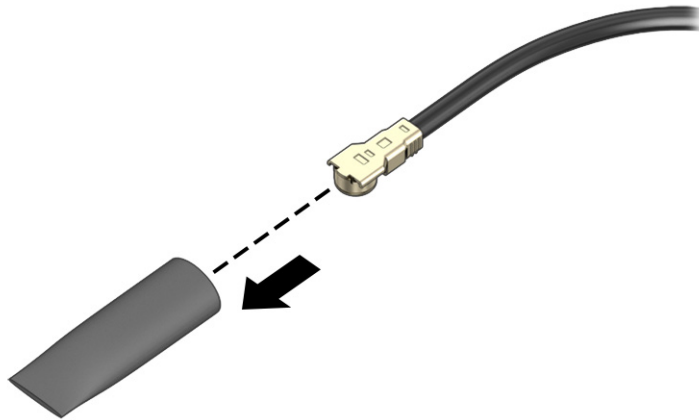

To install the WLAN module, reverse this procedure.

Speakers

To remove the speakers, use this procedure and illustration.

Table 6-4 Speaker description and part number

Description	Spare part number
Speaker Kit	N13315-001

Before removing the speakers, follow these steps:

1. Prepare the computer for disassembly (see [Preparation for disassembly on page 38](#)).
2. Remove the bottom cover (see [Bottom cover on page 38](#)).
3. Disconnect the battery cable from the system board (see [Battery on page 40](#)).

Remove the speakers:

1. Remove the two Phillips M2.0 × 2.0 broadhead screws **(1)** that secure each speaker to the computer.
2. Disconnect the speaker cables from the system board **(2)**.
3. Remove the speakers from the computer **(3)**.



NOTE: When removing the speakers, make note of the location of the rubber isolators. The absence of or damage to these isolators can result in degraded speaker performance.

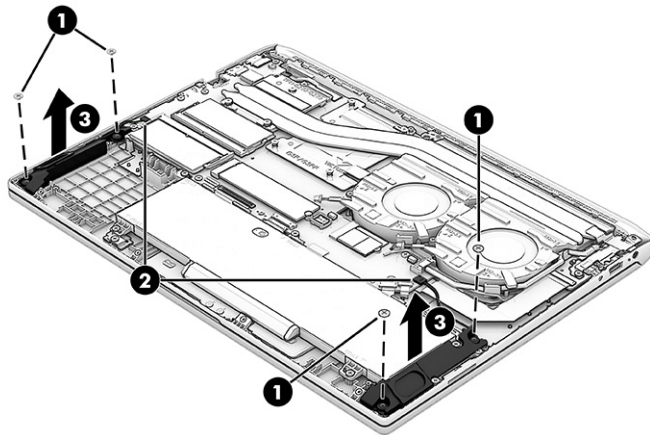

To install the speakers, reverse this procedure.

Fan assembly

To remove the fan assembly, use this procedure and illustration.

Table 6-5 Fan description and part number

Description	Spare part number
Fan assembly	N13304-001

Before removing the fan assembly, follow these steps:

1. Prepare the computer for disassembly (see [Preparation for disassembly on page 38](#)).
2. Remove the bottom cover (see [Bottom cover on page 38](#)).
3. Disconnect the battery cable from the system board (see [Battery on page 40](#)).

Remove the fan assembly:

1. Remove the power connector cable and WLAN antenna cables from the clips in the fan assembly **(1)**.
2. Disconnect the fan cables from the system board **(2)**.
3. Remove the six Phillips M2.0 × 3.5 screws **(3)** that secure the fan assembly to the computer.

4. Remove the fan assembly from the computer (4).

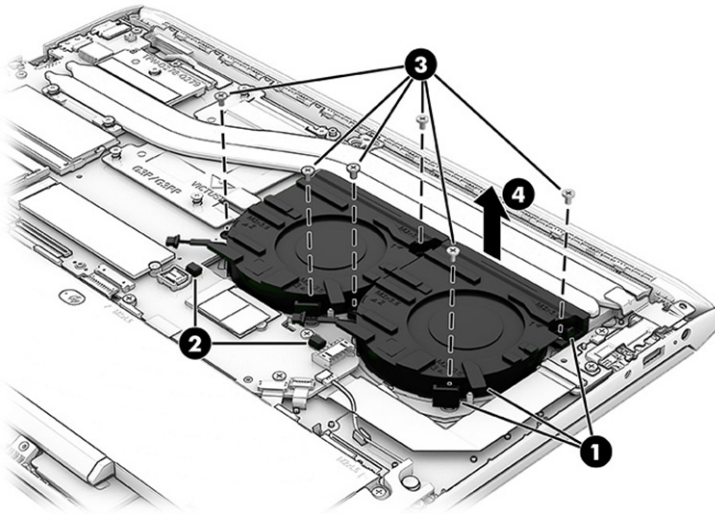

To install the fan assembly, reverse this procedure.

Power connector cable

To remove the power connector cable, use this procedure and illustration.

Table 6-6 Power connector cable description and part number

Description	Spare part number
Power connector cable	N13314-001

Before removing the power connector cable, follow these steps:

1. Prepare the computer for disassembly (see [Preparation for disassembly on page 38](#)).
2. Remove the bottom cover (see [Bottom cover on page 38](#)).
3. Disconnect the battery cable from the system board (see [Battery on page 40](#)).

Remove the power connector cable:

1. Remove the Phillips M2.0 × 4.0 screws (1) that secures the bracket, and then remove the bracket (2).
2. Disconnect the cable from the system board (3).

3. Remove the cable from the clips on the fan assembly (4).

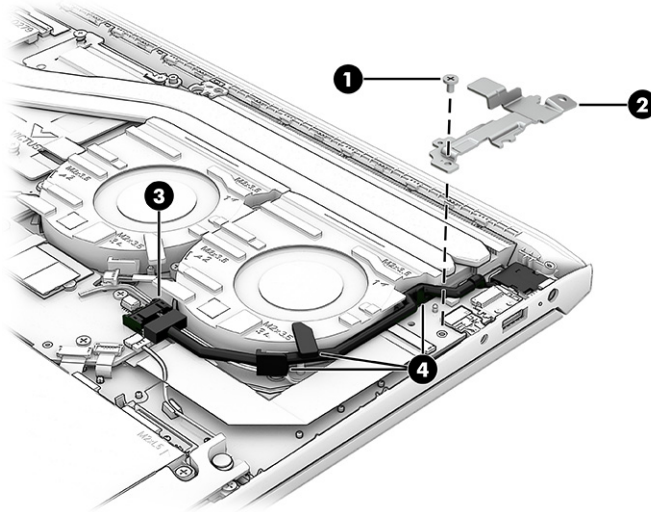

To install the power connector cable, reverse this procedure.

I/O board

To remove the I/O board, use this procedure and illustration.

Table 6-7 I/O board description and part number

Description	Spare part number
I/O board	N13300-001
I/O board cable	N13301-001

Before removing the I/O board, follow these steps:

1. Prepare the computer for disassembly (see [Preparation for disassembly on page 38](#)).
2. Remove the bottom cover (see [Bottom cover on page 38](#)).
3. Disconnect the battery cable from the system board (see [Battery on page 40](#)).

Remove the I/O board:

1. Remove the Phillips M2.0 × 3.0 screw (1) that secures the bracket to the computer, and then remove the bracket (2).
2. Disconnect the cable from the ZIF connector on the I/O board (3).

3. Lift the back of the board up, and then pull the board into the computer to remove it (4).

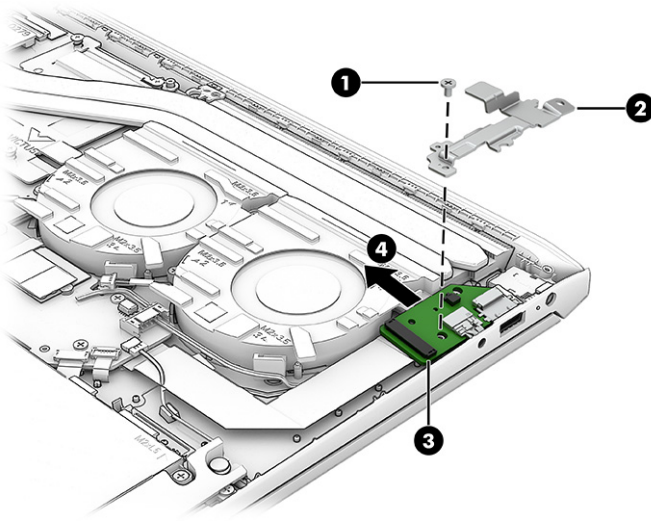

To install the I/O board, reverse this procedure.

Card reader

To remove the card reader, use this procedure and illustration.

Table 6-8 Card reader description and part number

Description	Spare part number
Card reader	N13302-001
Card reader cable	N13303-001

Before removing the card reader, follow these steps:

1. Prepare the computer for disassembly (see [Preparation for disassembly on page 38](#)).
2. Remove the bottom cover (see [Bottom cover on page 38](#)).
3. Remove the battery (see [Battery on page 40](#)).

Remove the card reader board:

1. Disconnect the cable from the ZIF connector on the system board (1).
2. Remove the Phillips M2.0 × 4.0 screw (2) that secures the bracket, and then remove the bracket (3).
3. Remove the two Phillips M2.0 × 2.5 screws (4) that secure the card reader to the computer.

4. Remove the card reader (5).

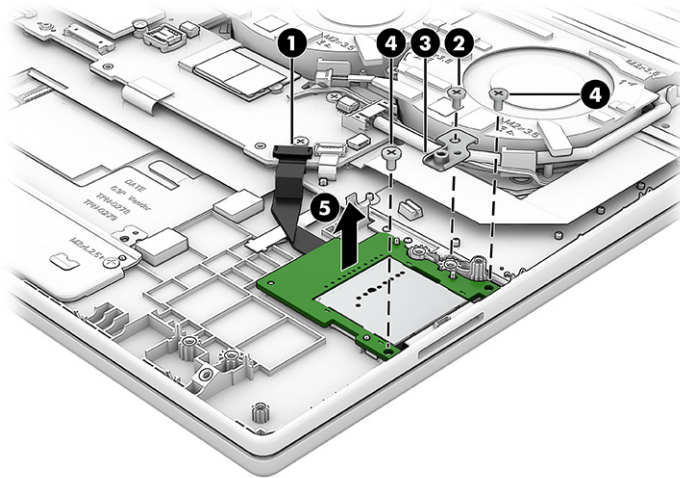

To install the card reader, reverse this procedure.

Heat sink

To remove the heat sink, use these procedures and illustrations.

Table 6-9 Heat sink descriptions and part numbers

Description	Spare part number
Heat sink for use in models with RTX 3050 or 3050Ti	N13305-001
Heat sink for use in models with GTX 1650 graphics	N13306-001
Heat sink for use in models with RX 6500M graphics	N14593-001

Before removing the heat sink, follow these steps:

1. Prepare the computer for disassembly (see [Preparation for disassembly on page 38](#)).
2. Remove the bottom cover (see [Bottom cover on page 38](#)).
3. Disconnect the battery cable from the system board (see [Battery on page 40](#)).

Remove the heat sink:

1. Remove the Phillips M2.0 × 2.0 screw (1) from the plastic holder at the top of the computer, and then remove the holder (2).
2. In the order indicated on the heat sink, loosen the seven captive Phillips screws (3) that secure the heat sink to the system board.

- Lift the left side of the heat sink up, and then pull it up and left to remove it (4).

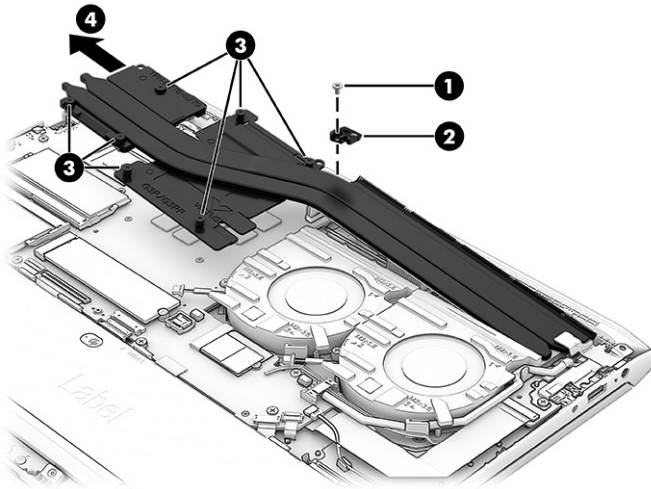

- Thoroughly clean the thermal material from the surfaces of the heat sink and the system board components each time the heat sink is removed. Replacement thermal material is included with the heat sink and system board spare part kits. The following illustrations show the replacement thermal material locations.

Thermal paste is used on the heat sink (1) and on the processor component on the system board (2).

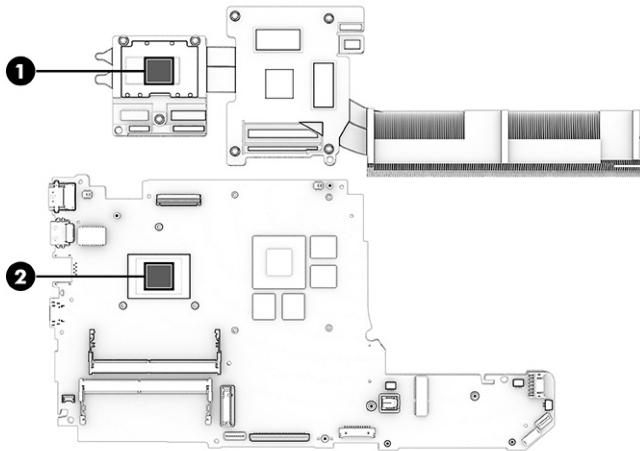

To install the heat sink, reverse this procedure.

System board

To remove the system board, use these procedures and illustrations.

Table 6-10 System board descriptions and part numbers

Description	Spare part number
AMD Ryzen7-5800H processor and AMD Radeon RX6500M graphics	N14592-xx1
AMD Ryzen7-5800H processor and NVIDIA GeForce RTX 3050 graphics	N14588-xx1

Table 6-10 System board descriptions and part numbers (continued)

Description	Spare part number
AMD Ryzen7-5800H processor and NVIDIA GeForce RTX 3050 Ti graphics	N14590-xx1
AMD Ryzen7-5800H processor and NVIDIA GeForce GTX 1650 graphics	N14586-xx1
AMD Ryzen5-5600H processor and AMD Radeon RX6500M graphics	N14591-xx1
AMD Ryzen5-5600H processor and NVIDIA GeForce RTX 3050 graphics	N14587-xx1
AMD Ryzen5-5600H processor and NVIDIA GeForce RTX 3050 Ti graphics	N14589-xx1
AMD Ryzen5-5600H processor and NVIDIA GeForce GTX 1650 graphics	N14585-xx1
System board repair kit	N19085-001

Before removing the system board, follow these steps:

1. Prepare the computer for disassembly (see [Preparation for disassembly on page 38](#)).
2. Remove the bottom cover (see [Bottom cover on page 38](#)).
3. Remove the battery (see [Battery on page 40](#)).
4. Remove the solid-state drive (see [Solid-state drive on page 34](#)).
5. Remove the fan assembly (see [Fan assembly on page 47](#)).
6. Remove the I/O board bracket (see [I/O board on page 49](#)).
7. If you need to replace the system board, remove the heat sink (see [Heat sink on page 51](#)).



NOTE: If you are not replacing the system board, do not remove the heat sink.

Remove the system board:

1. Disconnect the following cables from the system board:
 - Display cable **(1)** (ZIF)
 - Power connector cable **(2)**
 - I/O board cable from I/O board (ZIF) **(3)**
 - Left speaker cable **(4)**
 - Backlight cable (ZIF) **(5)**
 - Card reader cable (ZIF) **(6)**
 - Fan cable **(7)**
 - Wireless antenna cables from the WLAN module **(8)**
 - Fan cable **(9)**
 - Keyboard cable (ZIF) **(10)**
 - Touchpad cable (ZIF) **(11)**

- Right speaker cable (12)

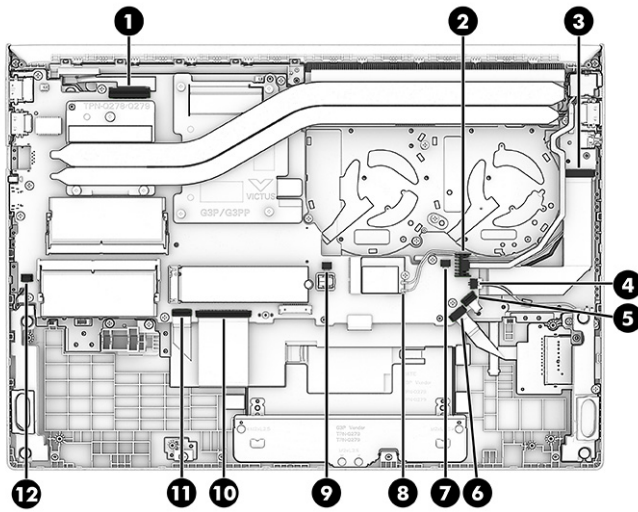

2. Remove the nine Phillips M2.0 × 4.0 screws that secure the system board to the computer.

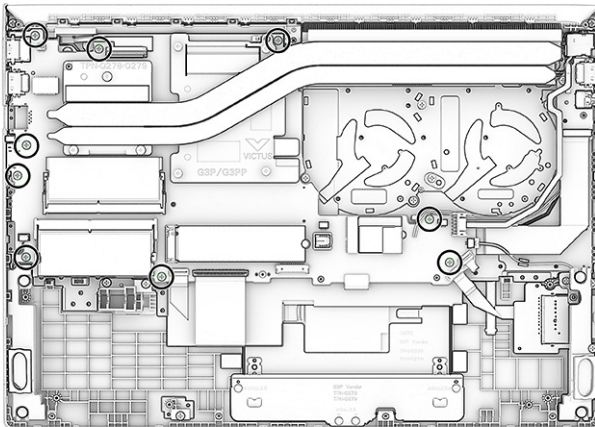

3. Lift the right edge of the system board, and then pull the board up and to the right to remove it from the computer (2).

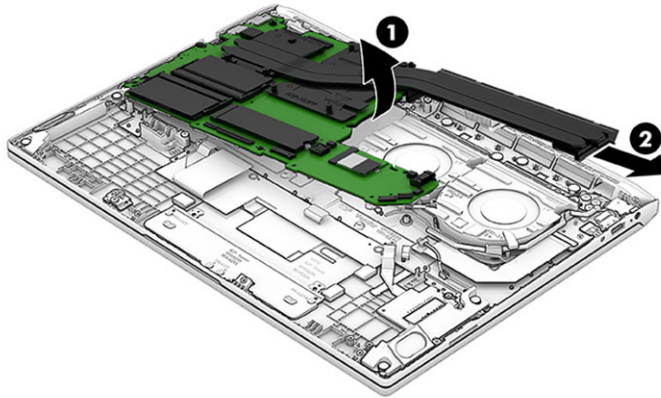

To install the system board, reverse this procedure.

Touchpad

To remove the touchpad, use this procedure and illustration.

Table 6-11 Touchpad description and part number

Description	Spare part number
Touchpad, ceramic white	N13309-001
Touchpad, mica silver	N13310-001
Touchpad, performance blue	N13311-001
Touchpad cable	N13312-001

Before removing the touchpad, follow these steps:

1. Prepare the computer for disassembly (see [Preparation for disassembly on page 38](#)).
2. Remove the bottom cover (see [Bottom cover on page 38](#)).
3. Remove the battery (see [Battery on page 40](#)).
4. Remove the fan assembly (see [Fan assembly on page 47](#)).
5. Remove the system board with the heat sink installed (see [System board on page 52](#)).

Remove the touchpad:

1. Remove the four Phillips M2.0 × 2.0 screws (1) that secure the touchpad bracket, and then remove the bracket (2).

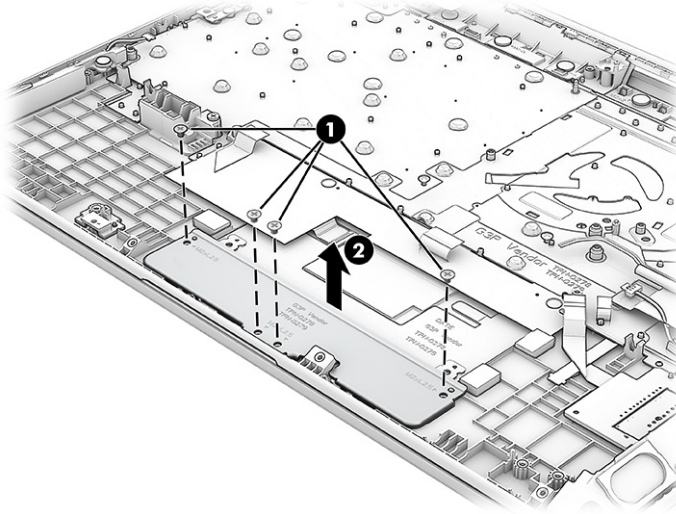

2. Remove the protective tape from the connector on the touchpad (1).
3. Disconnect the cable (2) from the touchpad ZIF connector.
4. Lift the keyboard cable that covers the touchpad screws (3).
5. Remove the Mylar that covers the screws (4).
6. Remove the grounding tape from the right screw (5).

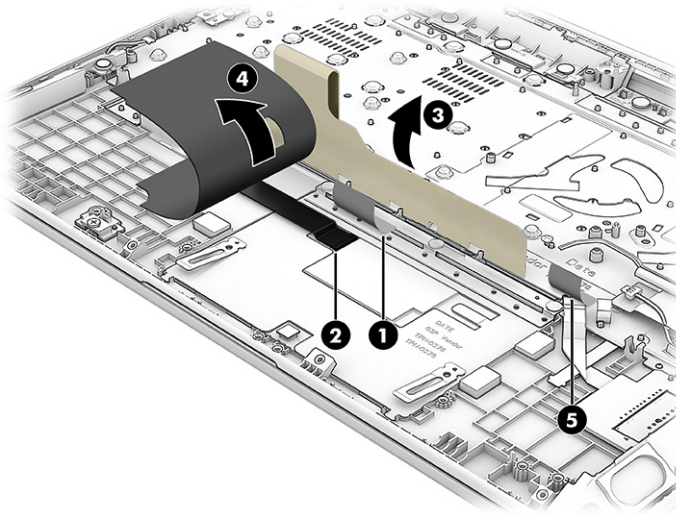

7. Remove the three Phillips M2.0 × 2.5 screws (1) that secure the touchpad to the computer.

8. Remove the touchpad (2).

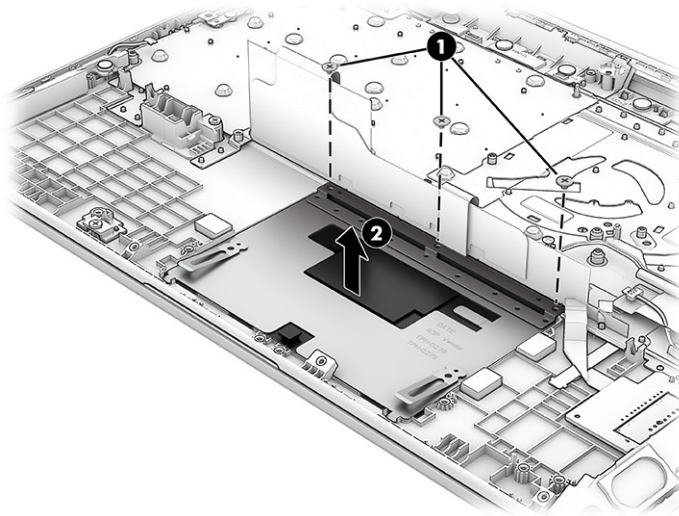

To install the touchpad, reverse this procedure.

Plastic rear vent and fin

To remove the plastic rear vent and fin, use this procedure and illustration.

Table 6-12 Plastic rear vent and fin descriptions and part numbers

Description	Spare part number
Dummy fin	N13308-001
Plastic rear vent	N13307-001

Before removing the plastic rear vent and fin, follow these steps:

1. Prepare the computer for disassembly (see [Preparation for disassembly on page 38](#)).
2. Remove the bottom cover (see [Bottom cover on page 38](#)).
3. Remove the battery (see [Battery on page 40](#)).
4. Remove the fan assembly (see [Fan assembly on page 47](#)).
5. Remove the system board with the heat sink installed (see [System board on page 52](#)).

Remove the plastic rear vent and fin:

1. Remove the four Phillips 2.0 × 2.0 broadhead screws (1) that secure the fin to the computer, and then remove the fin (2).

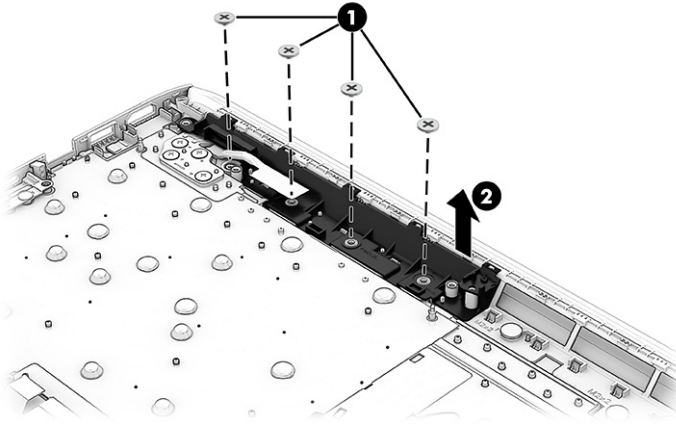

2. Remove the four Phillips M2.0 × 2.0 broadhead screws (1) and two Phillips M2.0 × 2.5 screws (2) that secure the plastic rear vent to the computer, and then remove the vent (3).

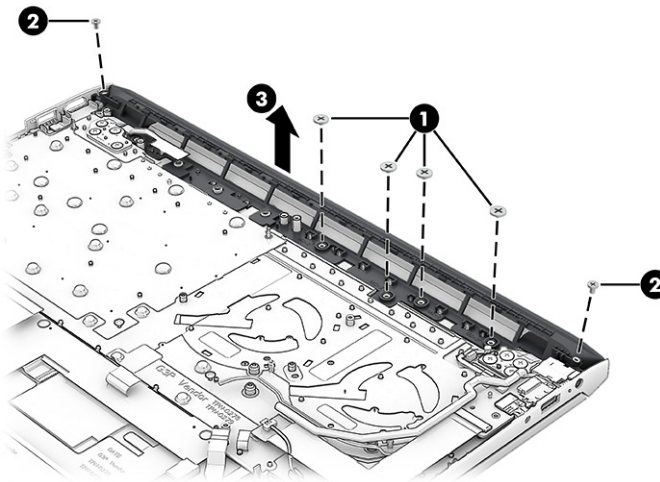

To install the plastic rear vent and fin, reverse these procedures.

Display assembly

To remove and disassemble the display assembly, use these procedures and illustrations.

 **NOTE:** You can remove the bezel, display panel, and camera module without removing the entire display assembly from the computer. For more information, see [Display subcomponents \(without removing the display\) on page 41](#). You do have to remove the display assembly to remove the remaining subcomponents.

Full hinge-up displays are not available as spare parts. Spare parts for displays are available only at the subcomponent level.

Before removing the display assembly, follow these steps:

1. Prepare the computer for disassembly (see [Preparation for disassembly on page 38](#)).
2. Remove the bottom cover (see [Bottom cover on page 38](#)).
3. Remove the battery (see [Battery on page 40](#)).
4. Remove the fan assembly (see [Fan assembly on page 47](#)).
5. Remove the I/O board bracket (see [I/O board on page 49](#)).
6. Remove the system board with the heat sink installed (see [System board on page 52](#)).
7. Remove the plastic rear vent and fin (see [Plastic rear vent and fin on page 57](#)).

Remove the display assembly:

1. Open the display to open the hinges (1).
2. Remove the eight Phillips M2.6 × 4.5 screws (2) that secure the display assembly to the computer.
3. Separate the display from the computer (3).

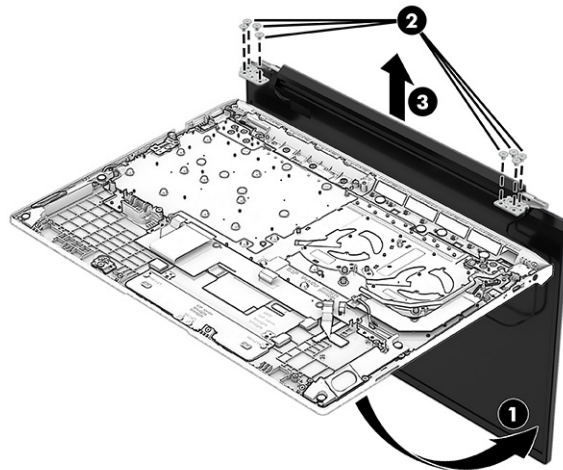

4. If you need to remove the bezel:
 - a. Flex the top (1), the left and right sides (2), and then the bottom of the bezel (3) to release it.
 - b. Remove the bezel from the display (4).

The display bezel is available as spare part number N13327-001.

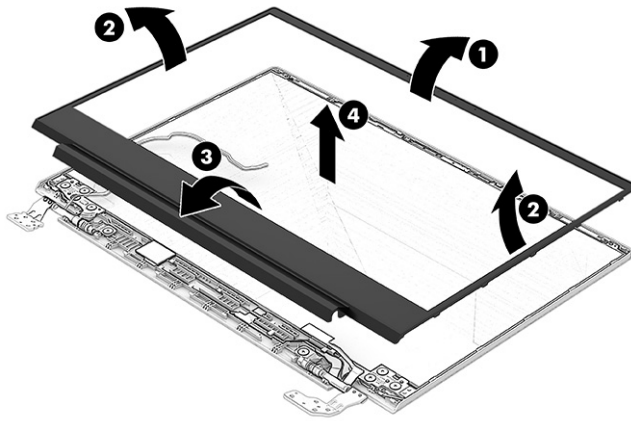

5. If you need to remove the display panel:

- a. At the top of the panel, use tweezers to grasp the end of the retention tape that is installed under the panel in three locations.
- b. While turning the tweezers (1), wrap the tape around the tweezers as you continue to pull the tape (2) out from behind the display panel.
- c. Rotate the panel up and set it next to the display back cover (3).

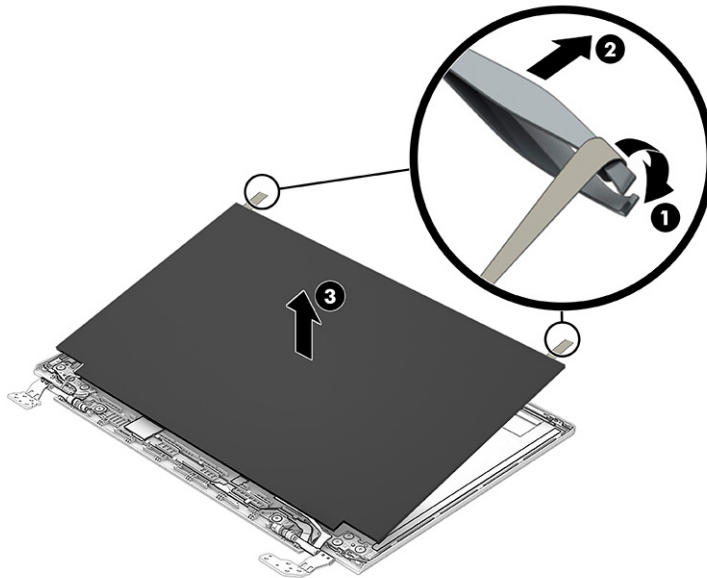

- d. To disconnect the cable from the display panel, lift the tape from the connector on the panel (1), and then disconnect the cable (2).

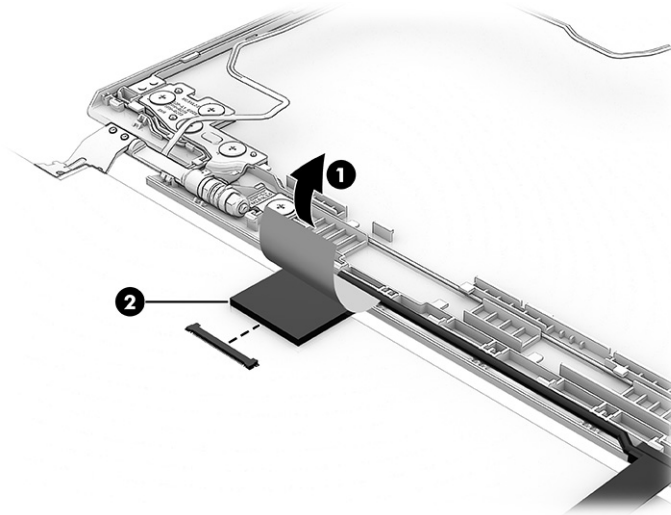

- e. When installing the display panel, install the adhesive strips on each side of the display back cover as shown in the following illustration.

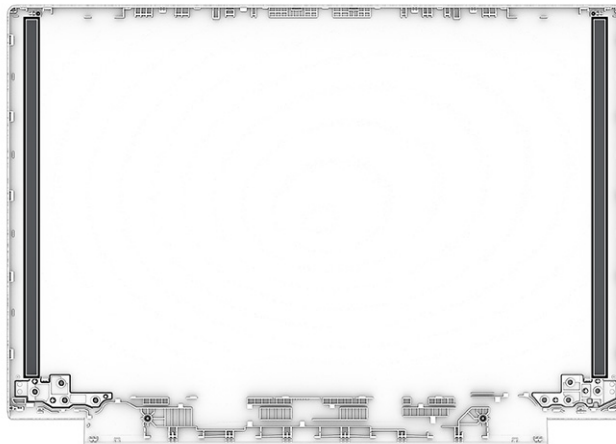

Display panels are available as the following spare part numbers:

N13293-001: FHD, SVA, 250 nits

N13294-001: FHD, UWVA, 250 nits

N13295-001: FHD, UWVA, 250 nits, 144 Hz

N13296-001: FHD, UWVA, 300 nits

The panel adhesive kit is available as spare part number N13334-001.

6. If you need to remove the camera module:

- a. Remove the two Phillips 1.6 × 2.5 screws (1) that secure the top bracket, lift up the hinge brackets slightly (2), and then pull the top bracket out from under the hinge brackets to remove it (3). The top bracket is available as spare part number N13330-001.

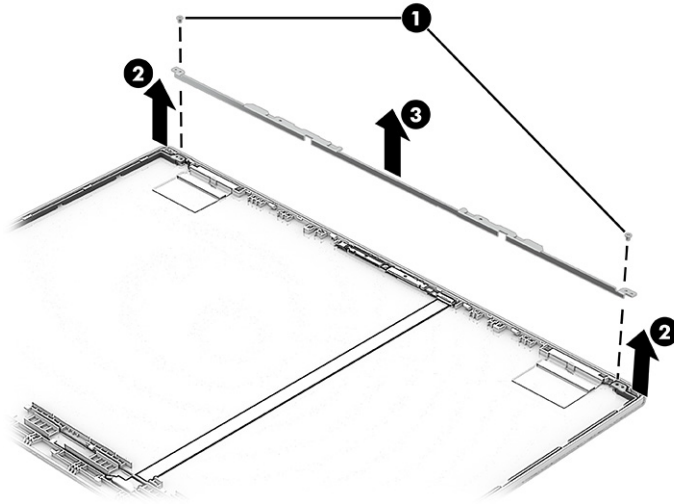

- b. Use a tool to lift up evenly across the module and peel the module up from the display back cover (1), and then disconnect the cable from the reverse ZIF connector on the module (2). The camera module is available as spare part number N13328-001.



NOTE: For installation, note that the cable routes under the camera module before it connects to the module.

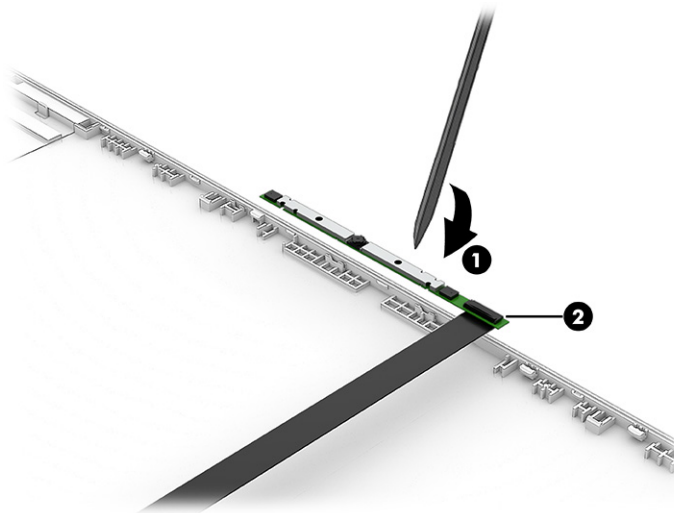

7. If you need to remove the hinges from the display back cover:
 - a. Remove the five broadhead Phillips M2.0 × 2.0 screws (1) from each hinge.
 - b. Remove the display hinges (2).

The display hinges are available using spare part number N13329-001.

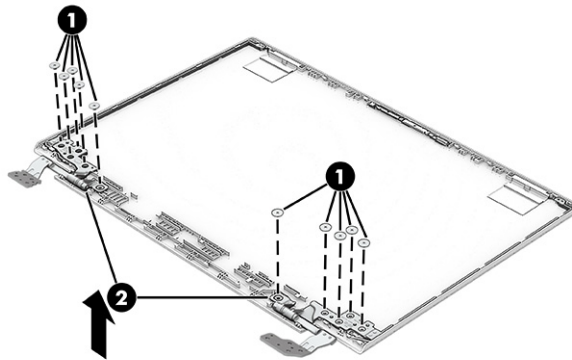

8. If you need to remove the display cable:

- Peel the cable off the inside of the display rear cover **(1)**.

The display cable is available as the following spare part numbers:

N13331-001: 144 Hz models

N13332-001: Standard models

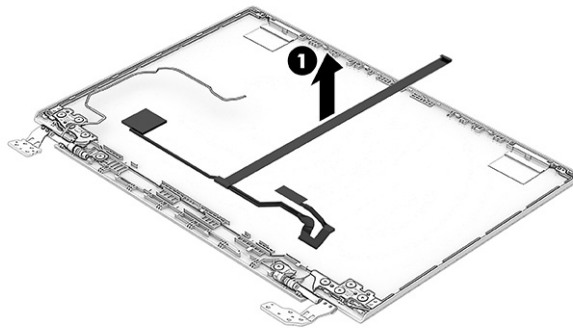

9. If you need to remove the WLAN antennas:

- a. Release the wireless antenna cables from the retention clips **(1)** on the display back cover.
- b. Peel the wireless antennas off the display rear cover **(2)**. (The antennas are attached with double-sided adhesive.) The wireless antennas are available using spare part number N13325-001 for models with a 300 nit panel and N13326-001 for models with a 250 nit panel.

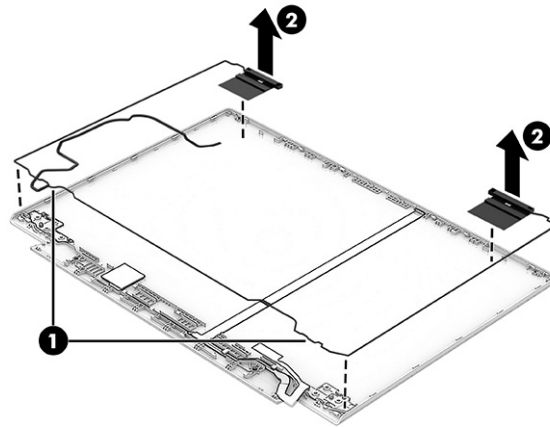

Display rear covers are available as the following spare part numbers:

- N13319-001: 300 nit panel, ceramic white
- N13320-001: 300 nit panel, mica silver
- N13321-001: 300 nit panel, performance blue
- N13322-001: 250 nit panel, ceramic white
- N13323-001: 250 nit panel, mica silver
- N13324-001: 250 nit panel, performance blue

To reassemble and replace the display assembly, reverse this procedure.

Top cover with keyboard

The top cover with keyboard remains after removing all other spare parts from the computer. In this section, the first table provides the main spare part number for the top cover with keyboard. The second table provides the country codes.

Table 6-13 Top cover with keyboard descriptions and part numbers

Description	Spare part number
Top cover with keyboard, ceramic white	N13297-xx1
Top cover with keyboard, mica silver	N13298-xx1
Top cover with keyboard, performance blue	N13299-xx1

Table 6-14 Spare part country codes

For use in country or region	Spare part number	For use in country or region	Spare part number	For use in country or region	Spare part number
Belgium	-A41	Hungary	-211	Saudi Arabia	-171
Brazil	-201	Iceland	-DD1	Slovenia	-BA1
Bulgaria	-261	India	-D61	South Korea	-AD1
Chile	-161	Israel	-BB1	Spain	-071

Table 6-14 Spare part country codes (continued)

For use in country or region	Spare part number	For use in country or region	Spare part number	For use in country or region	Spare part number
Czech Republic/Slovakia	-FL1	Italy	-061	Switzerland	-BG1
Denmark	-081	Japan	-291	Taiwan	-AB1
Denmark, Finland, and Norway	-DH1	The Netherlands	-B31	Thailand	-281
French Canada	-DB1	Northern Africa	-FP1	Turkey	-141
Finland/Sweden	-B71	Norway	-091	Turkey-F	-541
France	-051	Portugal	-131	Ukraine	-BD1
Germany	-041	Romania	-271	United Kingdom	-031
Greece	-151	Russia	-251	United States	-001

7 Using Setup Utility (BIOS)

Setup Utility, or Basic Input/Output System (BIOS), controls communication between all the input and output devices on the system (such as disk drives, display, keyboard, mouse, and printer). Setup Utility (BIOS) includes settings for the types of devices installed, the startup sequence of the computer, and the amount of system and extended memory.

 **NOTE:** To start Setup Utility on convertible computers, your computer must be in notebook mode and you must use the keyboard attached to your notebook.

Starting Setup Utility (BIOS)

You have several ways to access the Setup Utility (BIOS).

 **IMPORTANT:** Use extreme care when making changes in Setup Utility (BIOS). Errors can prevent the computer from operating properly.

- Turn on or restart the computer and quickly press **f10**.

– or –

Turn on or restart the computer, quickly press **esc**, and then press **f10** when the Start menu is displayed.

Updating Setup Utility (BIOS)

Updated versions of Setup Utility (BIOS) might be available on the HP website. Most BIOS updates on the HP website are packaged in compressed files called *SoftPaqs*. Some download packages contain a file named *Readme.txt*, which contains information regarding installing and troubleshooting the file.

Determining the BIOS version

To decide whether you need to update Setup Utility (BIOS), first determine the BIOS version on your computer.

To reveal the BIOS version information (also known as *ROM date* and *System BIOS*), use one of these options.

- HP Support Assistant
 1. Select the **Search** icon in the taskbar, type `support` in the search box, and then select the **HP Support Assistant** app.
– or –
Select the question mark icon in the taskbar.
 2. Under **My notebook**, select **Specifications**.
- Setup Utility (BIOS)
 1. Start Setup Utility (BIOS) (see [Starting Setup Utility \(BIOS\) on page 66](#)).
 2. Select **Main**, and then make note of the BIOS version.

3. Select **Exit**, select one of the options, and then follow the on-screen instructions.
- In Windows, press **ctrl+alt+s**.

To check for later BIOS versions, see [Preparing for a BIOS update on page 67](#).

Preparing for a BIOS update

Be sure to follow all prerequisites before downloading and installing a BIOS update.

 **IMPORTANT:** To reduce the risk of damage to the computer or an unsuccessful installation, download and install a BIOS update only when the computer is connected to reliable external power using the AC adapter. Do not download or install a BIOS update while the computer is running on battery power, docked in an optional docking device, or connected to an optional power source. During the download and installation, follow these instructions:

- Do not disconnect power from the computer by unplugging the power cord from the AC outlet.
- Do not shut down the computer or initiate Sleep.
- Do not insert, remove, connect, or disconnect any device, cable, or cord.

 **NOTE:** If your computer is connected to a network, consult the network administrator before installing any software updates, especially system BIOS updates.

Downloading a BIOS update

After you review the prerequisites, you can check for and download BIOS updates.

1. Select the **Search** icon in the taskbar, type `support` in the search box, and then select the **HP Support Assistant** app.
– or –
Select the question mark icon in the taskbar.
2. Select **Updates**. The **Checking for Updates** window opens, and Windows checks for updates.
3. Follow the on-screen instructions.
4. At the download area, follow these steps:
 - a. Identify the most recent BIOS update and compare it to the BIOS version currently installed on your computer. If the update is more recent than your BIOS version, make a note of the date, name, or other identifier. You might need this information to locate the update later, after it has been downloaded to your hard drive.
 - b. Follow the on-screen instructions to download your selection to the hard drive.

Make a note of the path to the location on your hard drive where the BIOS update is downloaded. You will need to access this path when you are ready to install the update.

Installing a BIOS update

BIOS installation procedures vary. Follow any instructions that appear on the screen after the download is complete. If no instructions appear, follow these steps.

1. Select the **Search** icon in the taskbar, type `file` in the search box, and then select **File Explorer**.
2. Select your hard drive designation. The hard drive designation is typically Local Disk (C:).

3. Using the hard drive path you recorded earlier, open the folder that contains the update.
4. Double-click the file that has an .exe extension (for example, *filename.exe*).
The BIOS installation begins.
5. Complete the installation by following the on-screen instructions.



NOTE: After a message on the screen reports a successful installation, you can delete the downloaded file from your hard drive.

8 Backing up, restoring, and recovering

You can use Windows tools or HP software to back up your information, create a restore point, reset your computer, create recovery media, or restore your computer to its factory state. Performing these standard procedures can return your computer to a working state faster.

 **IMPORTANT:** If you will be performing recovery procedures on a tablet, the tablet battery must be at least 70% charged before you start the recovery process.

 **IMPORTANT:** For a tablet with a detachable keyboard, connect the tablet to the keyboard base before beginning any recovery process.

Backing up information and creating recovery media

These methods of creating recovery media and backups are available on select products only.

Using Windows tools for backing up

HP recommends that you back up your information immediately after initial setup. You can do this task either using Windows Backup locally with an external USB flash drive or using online tools.

 **IMPORTANT:** Windows is the only option that allows you to back up your personal information. Schedule regular backups to avoid information loss.

 **NOTE:** If computer storage is 32 GB or less, Microsoft® System Restore is disabled by default.

Using the HP Cloud Recovery Download Tool to create recovery media (select products only)

You can use the HP Cloud Recovery Download Tool to create HP Recovery media on a bootable USB flash drive.

For details:

- Go to <http://www.hp.com>, search for HP Cloud Recovery, and then select the result that matches the type of computer that you have.

 **NOTE:** If you cannot create recovery media yourself, contact support to obtain recovery discs. Go to <http://www.hp.com/support>, select your country or region, and then follow the on-screen instructions.

 **IMPORTANT:** HP recommends that you follow the [Restoring and recovery methods on page 70](#) to restore your computer before you obtain and use the HP recovery discs. Using a recent backup can return your

machine to a working state sooner than using the HP recovery discs. After the system is restored, reinstalling all the operating system software released since your initial purchase can be a lengthy process.

Restoring and recovering your system

You have several tools available to recover your system both within and outside of Windows if the desktop cannot load.

HP recommends that you attempt to restore your system using the [Restoring and recovery methods on page 70](#).

Creating a system restore

System Restore is available in Windows. The System Restore software can automatically or manually create restore points, or snapshots, of the system files and settings on the computer at a particular point.

When you use System Restore, it returns your computer to its state at the time you made the restore point. Your personal files and documents should not be affected.

Restoring and recovery methods

After you run the first method, test to see whether the issue still exists before you proceed to the next method, which might now be unnecessary.

1. Run a Microsoft System Restore.
2. Run Reset this PC.



NOTE: The options **Remove everything** and then **Fully clean the drive** can take several hours to complete and leave no information on your computer. It is the safest way to reset your computer before you recycle it.

3. Recover using HP Recovery media. For more information, see [Recovering using HP Recovery media on page 70](#).

For more information about the first two methods, see the Get Help app:

- Select the **Start** button, select **All apps**, select the **Get Help** app, and then enter the task you want to perform.



NOTE: You must be connected to the internet to access the Get Help app.

Recovering using HP Recovery media

You can use HP Recovery media to recover the operating system and drivers that were installed at the factory. On select products, it can be created on a bootable USB flash drive using the HP Cloud Recovery Download Tool.

For details, see [Using the HP Cloud Recovery Download Tool to create recovery media \(select products only\) on page 69](#).



NOTE: If you cannot create recovery media yourself, contact support to obtain recovery discs. Go to <http://www.hp.com/support>, select your country or region, and then follow the on-screen instructions.

To recover your system:

- Insert the HP Recovery media, and then restart the computer.

 **NOTE:** HP recommends that you follow the [Restoring and recovery methods on page 70](#) to restore your computer before you obtain and use the HP recovery discs. Using a recent backup can return your machine to a working state sooner than using the HP recovery discs. After the system is restored, reinstalling all the operating system software released since your initial purchase can be a lengthy process.

Changing the computer boot order

If your computer does not restart using the HP Recovery media, you can change the computer boot order, the order of devices listed in BIOS for startup information. You can select an optical drive or a USB flash drive, depending on the location of your HP Recovery media.

 **IMPORTANT:** For a tablet with a detachable keyboard, connect the tablet to the keyboard base before beginning these steps.

To change the boot order:

1. Insert the HP Recovery media.
2. Access the system **Startup** menu.
 - For computers or tablets with keyboards attached, turn on or restart the computer or tablet, quickly press **esc**, and then press **f9** for boot options.
 - For tablets without keyboards, turn on or restart the tablet, quickly press and hold the volume up button, and then select **f9**.

– or –

Turn on or restart the tablet, quickly press and hold the volume down button, and then select **f9**.
3. Select the optical drive or USB flash drive from which you want to boot, and then follow the on-screen instructions.

Using HP Sure Recover (select products only)

Select computer models are configured with HP Sure Recover, a PC operating system (OS) recovery solution built into the hardware and software. HP Sure Recover can fully restore the HP OS image without installed recovery software.

Using HP Sure Recover, an administrator or user can restore the system and install:

- Latest version of the operating system
- Platform-specific device drivers
- Software applications, in the case of a custom image

To access the latest documentation for HP Sure Recover, go to <http://www.hp.com/support>. Follow the on-screen instructions to find your product and locate your documentation.

9 Using HP PC Hardware Diagnostics

You can use the HP PC Hardware Diagnostics utility to determine whether your computer hardware is running properly. The three versions are HP PC Hardware Diagnostics Windows, HP PC Hardware Diagnostics UEFI (Unified Extensible Firmware Interface), and (for select products only) Remote HP PC Hardware Diagnostics UEFI, a firmware feature.

Using HP PC Hardware Diagnostics Windows (select products only)

HP PC Hardware Diagnostics Windows is a Windows-based utility that allows you to run diagnostic tests to determine whether the computer hardware is functioning properly. The tool runs within the Windows operating system to diagnose hardware failures.

If HP PC Hardware Diagnostics Windows is not installed on your computer, first you must download and install it. To download HP PC Hardware Diagnostics Windows, see [Downloading HP PC Hardware Diagnostics Windows on page 73](#).

Using an HP PC Hardware Diagnostics Windows hardware failure ID code

When HP PC Hardware Diagnostics Windows detects a failure that requires hardware replacement, a 24-digit failure ID code is generated for select component tests. For interactive tests, such as keyboard, mouse, or audio and video palette, you must perform troubleshooting steps before you can receive a failure ID.

- You have several options after you receive a failure ID:
 - Select **Next** to open the Event Automation Service (EAS) page, where you can log the case.
– or –
 - Scan the QR code with your mobile device, which takes you to the EAS page, where you can log the case.
– or –
 - Select the box next to the 24-digit failure ID to copy your failure code and send it to support.

Accessing HP PC Hardware Diagnostics Windows

After HP PC Hardware Diagnostics Windows is installed, you can access it from HP Support Assistant or the Start menu.

Accessing HP PC Hardware Diagnostics Windows from HP Support Assistant

After HP PC Hardware Diagnostics Windows is installed, follow these steps to access it from HP Support Assistant.

1. Select the **Search** icon in the taskbar, type `support` in the search box, and then select the **HP Support Assistant** app.
– or –
Select the question mark icon in the taskbar.

2. Select **Fixes & Diagnostics**.
3. Select **Run hardware diagnostics**, and then select **Launch**.
4. When the tool opens, select the type of diagnostic test that you want to run, and then follow the on-screen instructions.

 **NOTE:** To stop a diagnostic test, select **Cancel**.

Accessing HP PC Hardware Diagnostics Windows from the Start menu (select products only)

After HP PC Hardware Diagnostics Windows is installed, follow these steps to access it from the Start menu.

1. Select the **Start** button, and then select **All apps**.
2. Select **HP PC Hardware Diagnostics Windows**.
3. When the tool opens, select the type of diagnostic test that you want to run, and then follow the on-screen instructions.

 **NOTE:** To stop a diagnostic test, select **Cancel**.

Downloading HP PC Hardware Diagnostics Windows

The HP PC Hardware Diagnostics Windows downloading instructions are provided in English only. You must use a Windows computer to download this tool because only .exe files are provided.

Downloading the latest HP PC Hardware Diagnostics Windows version from HP

To download HP PC Hardware Diagnostics Windows from HP, follow these steps.

1. Go to <http://www.hp.com/go/techcenter/pcdiags>. The HP PC Diagnostics home page is displayed.
2. Select **Download HP Diagnostics Windows**, and then select the specific Windows diagnostics version to download to your computer or a USB flash drive.

The tool downloads to the selected location.

Downloading the HP PC Hardware Diagnostics Windows from the Microsoft Store

You can download the HP PC Hardware Diagnostics Windows from the Microsoft Store.

1. Select the Microsoft Store app on your desktop or select the **Search** icon in the taskbar, and then type `Microsoft Store` in the search box.
2. Type `HP PC Hardware Diagnostics Windows` in the **Microsoft Store** search box.
3. Follow the on-screen directions.

The tool downloads to the selected location.

Downloading HP Hardware Diagnostics Windows by product name or number (select products only)

You can download HP PC Hardware Diagnostics Windows by product name or number.

 **NOTE:** For some products, you might have to download the software to a USB flash drive by using the product name or number.

1. Go to <http://www.hp.com/support>.
2. Select **Software and Drivers**, select your type of product, and then enter the product name or number in the search box that is displayed.
3. In the **Diagnostics** section, select **Download**, and then follow the on-screen instructions to select the specific Windows diagnostics version to be downloaded to your computer or USB flash drive.

The tool downloads to the selected location.

Installing HP PC Hardware Diagnostics Windows

To install HP PC Hardware Diagnostics Windows, navigate to the folder on your computer or the USB flash drive where the .exe file downloaded, double-click the .exe file, and then follow the on-screen instructions.

Using HP PC Hardware Diagnostics UEFI

HP PC Hardware Diagnostics UEFI (Unified Extensible Firmware Interface) allows you to run diagnostic tests to determine whether the computer hardware is functioning properly. The tool runs outside the operating system so that it can isolate hardware failures from issues that are caused by the operating system or other software components.



NOTE: For some products, you must use a Windows computer and a USB flash drive to download and create the HP UEFI support environment because only .exe files are provided. For more information, see [Downloading HP PC Hardware Diagnostics UEFI to a USB flash drive on page 75](#).

If your PC does not start in Windows, you can use HP PC Hardware Diagnostics UEFI to diagnose hardware issues.

Using an HP PC Hardware Diagnostics UEFI hardware failure ID code

When HP PC Hardware Diagnostics UEFI detects a failure that requires hardware replacement, a 24-digit failure ID code is generated.

For assistance in solving the problem:

- Select **Contact HP**, accept the HP privacy disclaimer, and then use a mobile device to scan the failure ID code that appears on the next screen. The HP Customer Support - Service Center page appears with your failure ID and product number automatically filled in. Follow the on-screen instructions.

– or –

Contact support, and provide the failure ID code.



NOTE: To start diagnostics on a convertible computer, your computer must be in notebook mode, and you must use the attached keyboard.



NOTE: If you need to stop a diagnostic test, press **esc**.

Starting HP PC Hardware Diagnostics UEFI

To start HP PC Hardware Diagnostics UEFI, follow this procedure.

1. Turn on or restart the computer, and quickly press **esc**.

2. Press **f2**.

The BIOS searches three places for the diagnostic tools, in the following order:

- a. Connected USB flash drive



NOTE: To download the HP PC Hardware Diagnostics UEFI tool to a USB flash drive, see [Downloading the latest HP PC Hardware Diagnostics UEFI version on page 75](#).

- b. Hard drive
- c. BIOS

3. When the diagnostic tool opens, select the type of diagnostic test that you want to run, and then follow the on-screen instructions.

Downloading HP PC Hardware Diagnostics UEFI to a USB flash drive

Downloading HP PC Hardware Diagnostics UEFI to a USB flash drive can be useful in some situations.

- HP PC Hardware Diagnostics UEFI is not included in the preinstallation image.
- HP PC Hardware Diagnostics UEFI is not included in the HP Tool partition.
- The hard drive is damaged.



NOTE: The HP PC Hardware Diagnostics UEFI downloading instructions are provided in English only, and you must use a Windows computer to download and create the HP UEFI support environment because only .exe files are provided.

Downloading the latest HP PC Hardware Diagnostics UEFI version

To download the latest HP PC Hardware Diagnostics UEFI version to a USB flash drive, follow this procedure.

1. Go to <http://www.hp.com/go/techcenter/pcdiags>. The HP PC Diagnostics home page is displayed.
2. Select **Download HP Diagnostics UEFI**, and then select **Run**.

Downloading HP PC Hardware Diagnostics UEFI by product name or number (select products only)

You can download HP PC Hardware Diagnostics UEFI by product name or number (select products only) to a USB flash drive.



NOTE: For some products, you might have to download the software to a USB flash drive by using the product name or number.

1. Go to <http://www.hp.com/support>.
2. Enter the product name or number, select your computer, and then select your operating system.

3. In the **Diagnostics** section, follow the on-screen instructions to select and download the specific UEFI Diagnostics version for your computer.

Using Remote HP PC Hardware Diagnostics UEFI settings (select products only)

Remote HP PC Hardware Diagnostics UEFI is a firmware (BIOS) feature that downloads HP PC Hardware Diagnostics UEFI to your computer. It can then execute the diagnostics on your computer, and it might upload results to a preconfigured server.

For more information about Remote HP PC Hardware Diagnostics UEFI, go to <http://www.hp.com/go/techcenter/pcdiags>, and then select **Find out more**.

Downloading Remote HP PC Hardware Diagnostics UEFI

HP Remote PC Hardware Diagnostics UEFI is also available as a SoftPaq that you can download to a server.

Downloading the latest Remote HP PC Hardware Diagnostics UEFI version

You can download the latest HP PC Hardware Diagnostics UEFI version to a USB flash drive.

1. Go to <http://www.hp.com/go/techcenter/pcdiags>. The HP PC Diagnostics home page is displayed.
2. Select **Download Remote Diagnostics**, and then select **Run**.

Downloading Remote HP PC Hardware Diagnostics UEFI by product name or number

You can download HP Remote PC Hardware Diagnostics UEFI by product name or number.



NOTE: For some products, you might have to download the software by using the product name or number.

1. Go to <http://www.hp.com/support>.
2. Select **Software and Drivers**, select your type of product, enter the product name or number in the search box that is displayed, select your computer, and then select your operating system.
3. In the **Diagnostics** section, follow the on-screen instructions to select and download the **Remote UEFI** version for the product.

Customizing Remote HP PC Hardware Diagnostics UEFI settings

Using the Remote HP PC Hardware Diagnostics setting in Computer Setup (BIOS), you can perform several customizations.

- Set a schedule for running diagnostics unattended. You can also start diagnostics immediately in interactive mode by selecting **Execute Remote HP PC Hardware Diagnostics**.
- Set the location for downloading the diagnostic tools. This feature provides access to the tools from the HP website or from a server that has been preconfigured for use. Your computer does not require the traditional local storage (such as a hard drive or USB flash drive) to run remote diagnostics.
- Set a location for storing the test results. You can also set the user name and password that you use for uploads.
- Display status information about the diagnostics run previously.

To customize Remote HP PC Hardware Diagnostics UEFI settings, follow these steps:

1. Turn on or restart the computer, and when the HP logo appears, press **f10** to enter Computer Setup.
2. Select **Advanced**, and then select **Settings**.
3. Make your customization selections.
4. Select **Exit**, then select **Save Changes and Exit** to save your settings.

Your changes take effect when the computer restarts.

10 Specifications

This chapter provides specifications for your computer system.

Computer specifications

This section provides specifications for your computer. When you travel with your computer, the computer dimensions and weights, as well as input power ratings and operating specifications, provide helpful information.

Table 10-1 Computer specifications

	Metric	U.S.
Dimensions		
Width	357.9 mm	14.1 in
Depth	255.0 mm	10.0 in
Height	23.5 mm	0.93 in
Weight		
	2296 g	5.06 lb
Input power		
Operating voltage and current	19.5 V dc @ 7.70 A – 150 W	
	19.5 V dc @ 10.3 A – 200 W	
Temperature		
Operating	5°C to 35°C	41°F to 95°F
Nonoperating	–20°C to 60°C	–4°F to 140°F
Relative humidity (noncondensing)		
Operating	10% to 90%	
Nonoperating	5% to 95%	
Maximum altitude (unpressurized)		
Operating	–15 m to 3,048 m	–50 ft to 10,000 ft
Nonoperating	–15 m to 12,192 m	–50 ft to 40,000 ft

Table 10-1 Computer specifications (continued)

	Metric	U.S.
NOTE: Applicable product safety standards specify thermal limits for plastic surfaces. The device operates well within this range of temperatures.		

Display specifications

This section provides specifications for your display.

Table 10-2 Display specifications

	Metric	U.S.
Active diagonal size	39.6 cm	15.6 in
Resolution	1920 × 1080 (FHD)	
Surface treatment	Antiglare	
Brightness	250 nits (45% NTSC) 300 nits (100% sRGB)	
Viewing angle	UWVA SVA	
Backlight	WLED	
Display panel interface	eDP	

Solid-state drive specifications

This section provides specifications for your solid-state drives.

Table 10-3 Solid-state drive specifications

	256 GB*	512 GB*	1 TB*
Dimensions			
Height	1.0 mm	1.0 mm	1.0 mm
Length	50.8 mm	50.8 mm	50.8 mm
Width	28.9 mm	28.9 mm	28.9 mm
Weight	< 10 g	< 10 g	< 10 g
Interface type			
Ready time, maximum (to not busy)	1.0 ms	< 1.0 ms	1.0 ms
Access times, logical	0.1 ms	0.1 ms	0.1 ms
Transfer rate			
Sequential read	up to 2150 MB/s	up to 2150 MB/s	up to 2150 MB/s
Random read	Up to 300,000 IOPs	Up to 300,000 IOPs	Up to 300,000 IOPs
Sequential write	up to 1550 MB/s	up to 1550 MB/s	up to 1550 MB/s

Table 10-3 Solid-state drive specifications (continued)

	256 GB*	512 GB*	1 TB*
Random write	Up to 100,000 IOPs	Up to 100,000 IOPs	Up to 100,000 IOPs
Total logical sectors	468,883,296	1,000,215,216	1,500,336,388
Operating temperature	0°C to 70°C (32°F to 158°F)		

*1 GB = 1 billion bytes when referring to hard drive storage capacity. Actual accessible capacity is less. Actual drive specifications may differ slightly.

NOTE: Certain restrictions and exclusions apply. Contact support for details.

11 Power cord set requirements

This chapter provides power cord requirements for countries and regions.

The wide-range input feature of the computer permits it to operate from any line voltage from 100 V ac to 120 V ac, or from 220 V ac to 240 V ac.

The three-conductor power cord set included with the computer meets the requirements for use in the country or region where the equipment is purchased.

Power cord sets for use in other countries or regions must meet the requirements of the country and region where the computer is used.

Requirements for all countries

These power cord requirements are applicable to all countries and regions.

- The length of the power cord set must be at least **1.0 m** (3.3 ft) and no more than **2.0 m** (6.5 ft).
- All power cord sets must be approved by an acceptable accredited agency responsible for evaluation in the country or region where the power cord set will be used.
- The power cord sets must have a minimum current capacity of 10 A and a nominal voltage rating of 125 V ac or 250 V ac, as required by the power system of each country or region.
- The appliance coupler must meet the mechanical configuration of an EN 60 320/IEC 320 Standard Sheet C13 connector for mating with the appliance inlet on the back of the computer.

Requirements for specific countries and regions

To determine power cord requirements for specific countries and regions, use this table.

Table 11-1 Power cord requirements for specific countries and regions

Country/region	Accredited agency	Applicable note number
Argentina	IRAM	1
Australia	SAA	1
Austria	OVE	1
Belgium	CEBEC	1
Brazil	ABNT	1
Canada	CSA	2
Chile	IMQ	1
Denmark	DEMKO	1
Finland	FIMKO	1
France	UTE	1
Germany	VDE	1

Table 11-1 Power cord requirements for specific countries and regions (continued)

Country/region	Accredited agency	Applicable note number
India	BIS	1
Israel	SII	1
Italy	IMQ	1
Japan	JIS	3
Netherlands	KEMA	1
New Zealand	SANZ	1
Norway	NEMKO	1
People's Republic of China	CCC	4
Saudi Arabia	SASO	7
Singapore	PSB	1
South Africa	SABS	1
South Korea	KTL	5
Sweden	SEMKO	1
Switzerland	SEV	1
Taiwan	BSMI	6
Thailand	TISI	1
United Kingdom	ASTA	1
United States	UL	2

1. The flexible cord must be Type H05VV-F, three-conductor, 0.75 mm² conductor size. Power cord set fittings (appliance coupler and wall plug) must bear the certification mark of the agency responsible for evaluation in the country or region where it will be used.
2. The flexible cord must be Type SVT/SJT or equivalent, No. 18 AWG, three-conductor. The wall plug must be a two-pole grounding type with a NEMA 5-15P (15 A, 125 V ac) or NEMA 6-15P (15 A, 250 V ac) configuration. CSA or C-UL mark. UL file number must be on each element.
3. The appliance coupler, flexible cord, and wall plug must bear a T mark and registration number in accordance with the Japanese Dentori Law. The flexible cord must be Type VCTF, three-conductor, 0.75 mm² or 1.25 mm² conductor size. The wall plug must be a two-pole grounding type with a Japanese Industrial Standard C8303 (7 A, 125 V ac) configuration.
4. The flexible cord must be Type RVV, three-conductor, 0.75 mm² conductor size. Power cord set fittings (appliance coupler and wall plug) must bear the CCC certification mark.
5. The flexible cord must be Type H05VV-F three-conductor, 0.75 mm² conductor size. KTL logo and individual approval number must be on each element. Approval number and logo must be printed on a flag label.
6. The flexible cord must be Type HVCTF three-conductor, 1.25 mm² conductor size. Power cord set fittings (appliance coupler, cable, and wall plug) must bear the BSMI certification mark.
7. For 127 V ac, the flexible cord must be Type SVT or SJT 3-conductor, 18 AWG, with plug NEMA 5-15P (15 A, 125 V ac), with UL and CSA or C-UL marks. For 240 V ac, the flexible cord must be Type H05VV-F three-conductor, 0.75 mm² or 1.00 mm² conductor size, with plug BS 1363/A with BSI or ASTA marks.

12 Recycling

When a nonrechargeable or rechargeable battery has reached the end of its useful life, do not dispose of the battery in general household waste. Follow the local laws and regulations in your area for battery disposal.

HP encourages customers to recycle used electronic hardware, HP original print cartridges, and rechargeable batteries. For more information about recycling programs, see the HP website at <http://www.hp.com/recycle>.

Index

- A**
 - AC adapter and battery light, identifying 6
 - AC adapter, spare part number 22
 - action key, identifying 14
 - antenna
 - illustrated 22
 - spare part number 22
 - audio-out (headphone)/audio-in (microphone) combo jack, identifying 7
 - audio, product description 2
- B**
 - backup, creating 69
 - backups 69
 - battery
 - illustrated 19
 - spare part number 19
 - BIOS
 - determining version 66
 - downloading an update 67
 - starting the Setup Utility 66
 - updating 66
 - Bluetooth label 16
 - boot order, changing 71
 - bottom components 15
 - bottom cover
 - illustrated 20
 - removal 38
 - spare part number 38
 - spare part numbers 20
 - buttons
 - left touchpad 9
 - power 13, 14
 - right touchpad 9
- C**
 - camera
 - identifying 8
 - camera light, identifying 8
 - camera/microphone module
 - illustrated 21
 - spare part number 21
 - caps lock light 11
 - card reader
 - illustrated 20
 - removal 50
 - spare part number 20, 50
 - caring for your computer 29
 - cautions
 - electrostatic discharge 25, 26
 - cleaning your computer 29
 - caring for wood veneer 31
 - disinfecting 30
 - HP Easy Clean 29
 - removing dirt and debris 29
 - components
 - bottom 15
 - display 7
 - keyboard area 9
 - left side 6
 - lights 11
 - rear 16
 - right side 5
 - touchpad 9, 10
 - computer major components 18
 - computer specifications 78
 - connectors
 - power 6
 - control zone 9
- D**
 - display
 - specifications 78, 79
 - display assembly
 - subcomponents 21
 - display back cover
 - illustrated 22
 - spare part numbers 22
 - display components 7
 - display panel
 - illustrated 21
 - product description 1
 - spare part numbers 21
 - display panel cable
 - illustrated 22
 - spare part number 22
 - dummy fin
 - illustrated 20
 - spare part number 20
- E**
 - electrostatic discharge (ESD) 25, 26
 - preventing damage 25-27
 - esc key, identifying 13
- F**
 - fan assembly
 - removal 47
 - spare part number 47
 - fn key, identifying 13
- G**
 - graphics controller, product description 1
 - grounding methods 25-27
 - guidelines
 - packaging 25, 31
 - transporting 25, 31
 - workstation 25
- H**
 - hard drive
 - product description 2
 - specifications 78
 - HDMI port
 - identifying 6
 - heat sink
 - removal 51
 - spare part numbers 51
 - heat sink assembly
 - illustrated 19
 - spare part numbers 19
 - hinge
 - illustrated 22
 - spare part numbers 22
 - HP PC Hardware Diagnostics UEFI
 - downloading 75
 - failure ID code 74
 - starting 74
 - using 74
 - HP PC Hardware Diagnostics Windows
 - accessing 72, 73
 - downloading 73
 - failure ID code 72
 - installing 74

- using 72
- HP Recovery media recovery 70
- HP Sure Recover 71

I

- I/O board
 - illustrated 20
 - removal 49
 - spare part number 20, 49
- illustrated parts catalog 18
- integrated numeric keypad, identifying 15
- internal microphones, identifying 8

J

- jacks
 - audio-out (headphone)/audio-in (microphone) 7
 - network 5
 - RJ-45 (network) 5

K

- keyboard
 - product description 3
- keypad, integrated numeric 15
- keys
 - action 14
 - esc 13
 - fn 13
 - num lock 14
 - Windows 14

L

- labels
 - Bluetooth 16
 - regulatory 16
 - serial number 16
 - service 16
 - wireless certification 16
 - WLAN 16
- left control zone, identifying 9, 10
- left side components 6
- lights
 - AC adapter and battery 6
 - camera 8
 - caps lock 11
 - mute 11
 - power 12
 - RJ-45 (network) status 5
 - touchpad 9, 11
- low blue light mode 7

M

- memory module
 - product description 1
- memory modules
 - removal 36
 - spare part numbers 36
- microphone
 - product description 2
- model name 1
- mute light, identifying 11

N

- network jack, identifying 5
- num lock key, identifying 14

O

- operating system, product description 4

P

- packaging guidelines 25, 31
- plastic rear vent
 - illustrated 20
 - spare part number 20
- pointing device, product description 3
- ports
 - HDMI 6
 - product description 2
 - USB SuperSpeed 5 Gbps 5
 - USB SuperSpeed 5 Gbps port with HP Sleep and Charge 6
 - USB Type-C SuperSpeed port with HP Sleep and Charge and DisplayPort output 5
- power button, identifying 13, 14
- power connector
 - identifying 6
- power connector cable
 - removal 48
 - spare part number 48
- power cord
 - requirements for all countries 81
 - requirements for specific countries and regions 81
 - set requirements 81
 - spare part numbers 23
- power light, identifying 12
- power requirements, product description 3
- primary storage
 - product description 2

- processor
 - product description 1
- processor, product description 1
- product description
 - audio 2
 - display panel 1
 - graphics controller 1
 - hard drive 2
 - keyboard 3
 - memory module 1
 - microphone 2
 - operating system 4
 - pointing device 3
 - ports 2
 - power requirements 3
 - primary storage 2
 - product name 1
 - security 3
 - serviceability 4
 - solid-state drive 2
 - video 2
 - wireless 2
- product name 1
- product name and number, computer 16

R

- recovery 69, 70
 - discs 70
 - media 70
 - USB flash drive 70
- recovery media 69
 - creating using HP Cloud Recovery Download Tool 69
 - creating using Windows tools 69
- regulatory information
 - regulatory label 16
 - wireless certification labels 16
- Remote HP PC Hardware Diagnostics UEFI settings
 - customizing 76
 - using 76
- removal and replacement procedures 34, 38
 - solid-state drive 34
- restoring 69
- restoring and recovery methods 70
- right control zone, identifying 9, 11
- right side components 5
- RJ-45 (network) jack, identifying 5
- RJ-45 (network) status lights, identifying 5

S

- security, product description 3
- serial number, computer 16
- service labels, locating 16
- serviceability, product description 4
- slots
 - memory card reader 7
- solid-state drive
 - illustrated 20
 - product description 2
 - removal and replacement 34
 - spare part numbers 20
 - specifications 79
- spare part country codes 64
- speaker
 - illustrated 19
 - removal 46
 - spare part number 19, 46
- speakers 15
- special keys
 - identifying 13
 - using 13
- specifications
 - computer 78
 - display 78, 79
 - hard drive 78
 - solid-state drive 79
- static electricity 25, 26
- support information 32
- system board
 - illustrated 19
 - removal 52
 - spare part numbers 19, 52
- system restore 70
- system restore point, creating 69

T

- top cover
 - spare part numbers 64
- touchpad
 - illustrated 19
 - removal 55
 - settings 9
 - spare part numbers 19, 55
- touchpad buttons
 - identifying 9
- touchpad components 9
- touchpad light, identifying 9, 11
- touchpad settings, adjusting 9
- touchpad zone, identifying 9, 10
- transporting guidelines 25, 31
- traveling with the computer 16

U

- USB SuperSpeed 5 Gbps port with HP Sleep and Charge, identifying 6
- USB SuperSpeed 5 Gbps port, identifying 5
- USB Type-C SuperSpeed port with HP Sleep and Charge and DisplayPort output, identifying 5

V

- vents
 - removal 57
 - spare part numbers 57
- vents, identifying 16
- video, product description 2

W

- Windows
 - backup 69
 - recovery media 69
 - system restore point 69
- Windows key, identifying 14
- Windows tools, using 69
- wireless antennas, identifying 8
- wireless certification label 16
- wireless, product description 2
- WLAN antenna kit
 - illustrated 22
 - spare part number 22
- WLAN antennas, identifying 8
- WLAN device 16
- WLAN label 16
- WLAN module
 - removal 45
 - spare part numbers 45
- workstation guidelines 25