

# Technical Description And User Manual

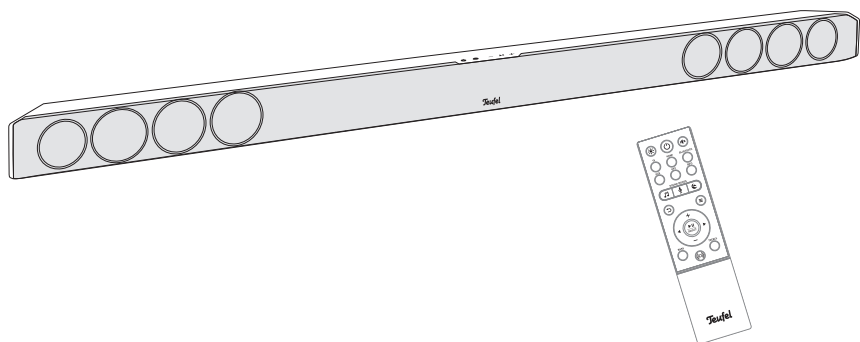

## CINEBAR 11

All-in-one soundbar with wireless technology

**Teufel**

# Contents

---

<b>General Notes And Information.....</b>	<b>3</b>	<b>Operation.....</b>	<b>25</b>
Trademarks .....	3	Activating and deactivating.....	25
Contact.....	5	Automatic activation .....	25
<b>For Your Safety.....</b>	<b>6</b>	Selecting a source .....	25
Proper use.....	6	Adjusting the volume .....	26
Safety notes .....	7	Mute .....	26
<b>Overview .....</b>	<b>11</b>	<b>Showing information.....</b>	<b>27</b>
Package contents .....	11	Adjusting the tone .....	27
<b>Operational Controls And Connections .....</b>	<b>12</b>	Dynamore®.....	27
<b>Remote Control .....</b>	<b>14</b>	Equalizer .....	27
Inserting/changing the batteries .....	16	Dolby Audio and DTS.....	28
<b>Setup.....</b>	<b>18</b>	Brightness of the display panel.....	28
Setup location .....	18	Menu.....	29
Wall mounting .....	19	“Sound” menu .....	30
<b>Connecting .....</b>	<b>21</b>	“Speaker” menu .....	31
TV set.....	21	“System” menu.....	32
HDMI source .....	21	<b>Bluetooth® Mode.....</b>	<b>35</b>
Optical-digital source.....	22	Pairing and connecting.....	35
Analogue source .....	22	Interruption of connection .....	36
Rear speakers and subwoofer.....	22	Terminating the connection .....	37
Power supply .....	23	Playback .....	37
First activation .....	24	<b>Software update .....</b>	<b>38</b>
		<b>Care And Cleaning.....</b>	<b>40</b>
		<b>Troubleshooting .....</b>	<b>41</b>
		<b>Declaration Of Conformity.</b>	<b>42</b>
		<b>Technical Data.....</b>	<b>43</b>

# General Notes And Information

---

## Notice

The information in this document may change without prior notice and in no way constitutes any liability on the part of Lautsprecher Teufel GmbH.

No part of this user manual may be reproduced in any form or be broadcasted in any way electronically, mechanically, by photocopy or recording without the written permission of Lautsprecher Teufel GmbH.

© Lautsprecher Teufel GmbH  
Version 3, November 2020

## Trademarks

® All trademarks are the property of their respective owners.

 **Bluetooth**® The Bluetooth® wordmarks and symbols are registered trademarks of Bluetooth SIG, Inc. Any use of these symbols by Lautsprecher Teufel occurs under licence.

## **Dolby** Audio

Manufactured under licence from Dolby Laboratories. Dolby, Dolby Audio, Pro Logic and the double D symbol are trademarks of Dolby Laboratories.

## **Qualcomm**® **aptX**™

Qualcomm aptX is a product of Qualcomm Technologies International, Ltd.

Qualcomm is a trademark of Qualcomm Incorporated, registered in the USA and other countries, whose use has been approved. aptX is a trademark of Qualcomm Technologies International, Ltd., registered in the USA and other countries, whose use has been approved.



For DTS patents, see <https://patents.dts.com>. Manufactured under license from DTS, Inc. (for companies headquartered in the U.S./Japan/Taiwan) or under license from DTS Licensing Limited (for all other companies). DTS, DTS Sound, and the DTS logo are registered trademarks or trademarks of DTS, Inc. in the United States and/or other countries. © 2020 DTS, Inc. ALL RIGHTS RESERVED.



The DMI and HDMI High-Definition Multimedia Interface symbols as well as the HDMI logo are trademarks or registered trademarks of HDMI Licensing Administrator Inc. in the USA and other countries.

## Original packaging

If you wish to exercise your eight-week right of return, we ask that you be absolutely sure to hold onto the packaging. We can only accept product returns with the ORIGINAL PACKAGING. Empty boxes are not available!

## Complaints

In case of a complaint we will need the following information to process your enquiry:

### 1. Invoice number

Can be found on the sales slip (enclosed with the product) or on the order confirmation received as a PDF document.

### 2. Serial number or batch number

Located on the bottom of the device.

Thank you for your support!

## Contact

Please contact our customer service department with any questions, suggestions, or complaints:

**Lautsprecher Teufel GmbH**  
**BIKINI Berlin**  
**Budapester Str. 44**  
**10787 Berlin (Germany)**

Telephone: +44 3308080489

Fax: +4930 300930930

Online support:

[www.teufelaudio.com/service](http://www.teufelaudio.com/service)

Contact form:

[www.teufelaudio.com/contact](http://www.teufelaudio.com/contact)



Before operating the product for the first time, please read the safety notes and user manual carefully. Only in this way, can you ensure that all functions are used in a safe and reliable manner. Store the user manual in a safe place and also be sure to pass it on to any subsequent owner.

### NOTICE

***Check that all items have been delivered and that nothing is damaged. If you find any damage, do not operate the device; instead contact our customer service department.***

# For Your Safety

---

## Proper use

The speaker is designed for the playback of music and speech from external players.

Only use the speaker as described in this user manual. Any other use will be deemed as not in accordance with the instructions and may lead to damage of property or even persons.

The manufacturer accepts no liability for damage caused by improper use.

The speaker is intended for private use.

## Explanation of terms

You can find the following signal terms in this user manual:

### **WARNING**

*This signal term indicates a moderate risk, which, if not avoided, may result in severe injury.*

### **CAUTION**

*This signal term indicates a low risk, which, if not avoided, may result in minor or moderate injury.*

### **NOTICE**

*This signal term warns you of potential damage.*

## Safety notes

This chapter contains general safety notes which you should always observe to protect yourself and third parties. Also observe the warning notes in each chapter of this user manual.

### WARNING

#### **Touching live parts can result in severe injury or death.**

- When connecting the mains adapter, make sure that the correct voltage is present. You can find more information about this on the rating plate of the mains adapter.
- Check the device regularly for damage. Immediately disconnect the mains plug and do not operate the device if its housing, mains adapter or mains cord is defective or exhibits other visible damages.
- This device is disconnected from the grid by pulling the mains plug. Thus, make sure that the mains plug is always easily accessible.
- If the device emits smoke or smells of burning or emits unusual sounds, disconnect it immediately from the mains and do not operate it anymore.
- Never open the housing of the device or mains adapter. Repairs may only be carried out by an authorised specialist workshop. Only parts that match the original specifications may be used.
- Only use the accessory products specified by the manufacturer.
- Only use the device indoors.
- Do not operate the device in wet rooms and protect it from dripping and splashing water. Make sure that no vases or other liquid-filled objects are located on or near the device in order to prevent liquid from penetrating the housing. If water or other debris ends up penetrating the housing, immediately pull the mains plug and, if applicable, take out any batteries. Then send the device to our service address.

- Never modify the device. Unauthorised modifications may affect the safety and functionality.
- Never touch the mains plug with wet hands.

### **⚠ WARNING**

#### **An unsuitable setup location may result in injury and damage.**

- Never use the device unmounted in vehicles, in unstable locations, on wobbly tripods or furniture, on insufficiently dimensioned brackets etc. The speaker could tip or fall down and cause injury to persons or be damaged itself.
- Arrange the device so that it cannot be knocked over accidentally and make sure that the cables do not pose a tripping hazard.
- Do not place the device and the mains adapter near heat sources (e.g. heaters, ovens, other heat generating equipment such as amplifiers etc.).
- Do not use the device in environments where there is a risk of explosion.
- Only use the wireless function (Bluetooth<sup>®</sup>, wireless

subwoofer) in locations where wireless radio transmission is allowed.

### **⚠ WARNING**

#### **Children can become trapped in the plastic wrapping when playing and suffocate.**

- Do not allow children to play with the device or the plastic wrapping. There is a danger of suffocation.
- Never allow children to operate electrical equipment unsupervised.

### **⚠ WARNING**

#### **Swallowing a product battery may result in severe internal injury or even death.**

- Store both new and used batteries so that they are not accessible to children.
- If it is no longer possible to safely close the battery compartment, stop using the remote control and store it so that it is not accessible for children.
- If you suspect that a battery has been swallowed or otherwise incorporated, promptly consult a physician.



**⚠ CAUTION**

**Extended listening at high volumes may lead to hearing loss.**

- To avoid damage to health, avoid extended listening at high volumes.
- When the volume is set high, always keep a certain distance from the device and never place your ears directly on the speaker.
- If your soundbar is set to full volume, it may produce very high sound pressure. This may have psychological consequences and also cause physical injury. Children and pets are particularly at risk. Set your signal source device volume to a low setting before turning on the power.

**⚠ CAUTION**

**This product contains magnetic material.**

- If necessary, consult your physician and ask about effects on implants such as pacemakers or defibrillators.

**⚠ CAUTION**

**Improper use may lead to damage or fire.**

- Do not place open flames such as burning candles or similar on the device.
- Ensure sufficient ventilation.
- Do not place the device in direct sunlight.

**⚠ CAUTION**

**Leaking battery acid may lead to chemical burns.**

- Do not allow battery acid to come into contact with skin, eyes or mucous membranes. In the event of contact with acid, immediately flush the applicable areas with plenty of clean water and consult a physician if necessary.

**⚠ CAUTION**

**Batteries (particularly lithium batteries) can explode if used improperly.**

- Never attempt to recharge batteries.
- Only use batteries of the same or equivalent type.
- You must not heat or short circuit batteries and rechargeable batteries or dispose of them in fire.



- Do not expose batteries and rechargeable batteries to direct sunlight.

## **NOTICE**

**The isolation pads can produce discolouration on sensitive surfaces.**

- On parquet, varnished wood and similar surfaces, you should stick felt gliders to the rubber feet of the device or put a blanket under it. This will prevent discolouration of the floor over the long term.

## **Explanation of symbols**

	Protection class II Dual insulation
	May only be used indoors
	Risk of electrical shock – do not open the housing

# Overview

---

## Unpacking

- Carefully open the box and carefully lift the device out of the box.

## Package contents

- (1) 1× CINEBAR 11
- (2) 1× remote control  
CINEBAR 11 MK2 20 RC
- (3) 1× mains adapter
- (4) 1× mains cord for (3)
- (5) 2× AAA batteries for (2)





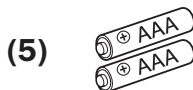
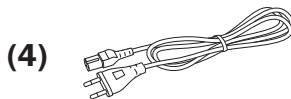
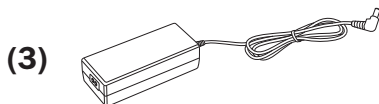
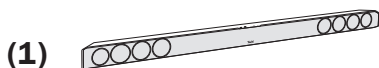

## Checking the package contents

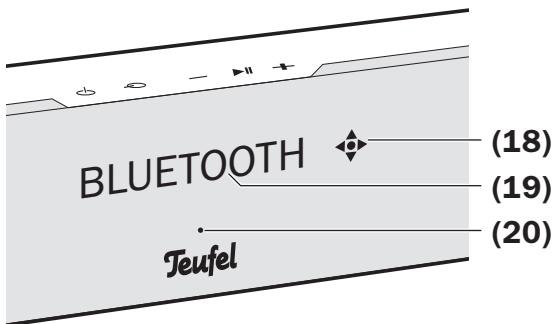
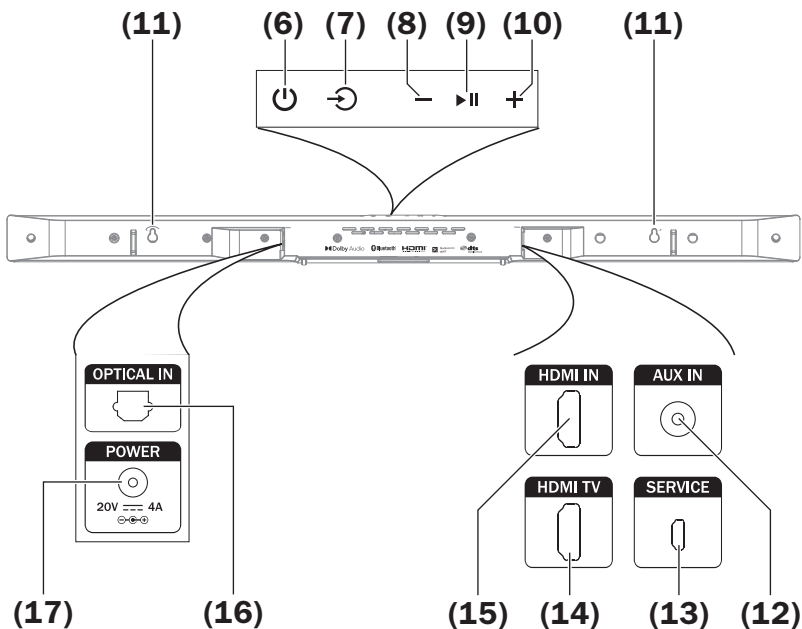
- Check that all items have been delivered and that nothing is damaged.
- If the delivery is incomplete or exhibits damage from transport, please contact our service team (see page 5).
- Do not in any case operate the device if it is damaged.











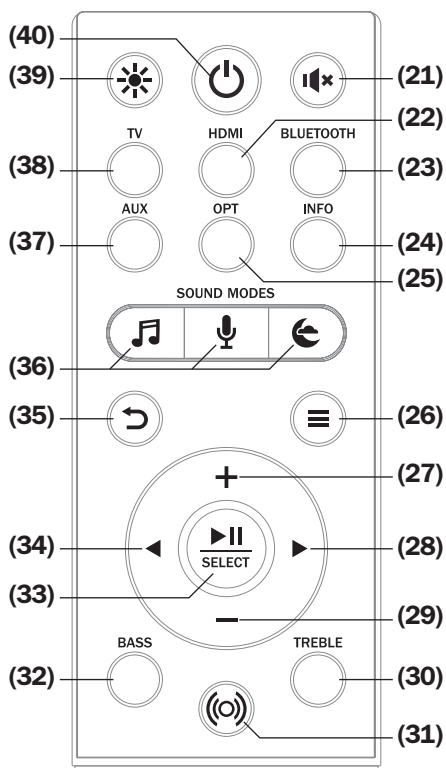

# Operational Controls And Connections



- (6)  – switch the device on or to standby
- (7)  – brief push: select source, long push: Bluetooth® pairing
- (8)  – decrease the volume, navigate through the menu
- (9)  – menu: confirm, mute on/off  
Bluetooth®: start/pause playback
- (10)  – increase the volume, navigate through the menu
- (11) 2× keyhole openings for wall mounting
- (12) **AUX IN** – input jack for analogue audio source device
- (13) **SERVICE** – micro-USB port for software updates
- (14) **HDMI TV** – HDMI connection for the TV set
- (15) **HDMI IN** – connection for an external HDMI device
- (16) **OPTICAL IN** – optical-digital audio input
- (17) **POWER** – connector jack for the mains adapter (3)
- (18)  – navigation arrows
- (19) Display panel
- (20) Standby display

# Remote Control



- (21)  – mute speaker
- (22) **HDMI** – select HDMI IN as source
- (23) **BLUETOOTH** – short push: Bluetooth® as source, long push: start pairing
- (24) **INFO** – show current parameters
- (25) **OPT** – OPTICAL IN source
- (26)  – access the menu
- (27) **+** – increase the volume, navigate through the menu
- (28)  – menu navigation, Bluetooth®: forward
- (29) **–** – decrease the volume, navigate through the menu
- (30) **TREBLE** – adjust the high range level
- (31)  – stereo widening switch Dynamore® on/off
- (32) **BASS** – adjust the low-range level
- (33)  – menu: confirm, mute on/off, Bluetooth®: start/pause playback
- (34)  – menu navigation, Bluetooth®: back
- (35)  – go back in the menu
- (36) **MODE** – set the equalizer: normal, voice, night
- (37) **AUX** – select AUX IN as source
- (38) **TV** – select TV as source
- (39)  – adjust the brightness of the display panel
- (40)  – switch the device on or to standby

**⚠ CAUTION**

**Leaking battery acid may lead to chemical burns.**

- Do not allow battery acid to come into contact with skin, eyes or mucous membranes. In the event of contact with acid, immediately flush the applicable areas with plenty of clean water and consult a physician if necessary.

**Batteries (particularly lithium batteries) can explode if used improperly.**

- Never attempt to recharge batteries.
- Only use batteries of the same or equivalent type.
- You must not heat or short circuit batteries and rechargeable batteries or dispose of them in fire.

- Do not expose batteries and rechargeable batteries to direct sunlight.

## **Inserting/changing the batteries**

The remote control is powered by 2 type AAA batteries.

You should change the batteries if the remote control stops working properly or after two years at the latest:

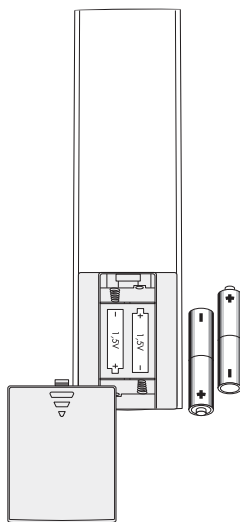



1. To open the battery compartment, gently push on the grooved arrow and push the cover down to open it.
2. If applicable, remove the old batteries and dispose of them in an environmentally-friendly manner.
3. Insert the new batteries as shown in the figure in the battery compartment.
4. Place the cover back on the compartment and push it up to close it.



**Batteries and rechargeable batteries do not belong in the household garbage!**

Every consumer is required by law to bring all batteries and rechargeable batteries, regardless whether they contain harmful substances\*) or not, to a collection point run by the communal authority or borough or to a retailer, so that they can be disposed of in an environmentally friendly manner.

Please only turn in batteries and rechargeable batteries which are empty!

\*) labelled with: Cd = cadmium, Hg = mercury, Pb = lead



**Old devices must not be disposed of with household waste!**

Electrical equipment contains harmful substances and valuable resources.

Every consumer is required by law to bring all old electrical devices to an authorised collection or return point so that they can be disposed of in a manner that is environmentally friendly and which preserves resources.

You can hand old electrical devices over to the local reusable materials/recycling centre.

Please contact your vendor directly for more information about this topic.

# Setup

---

## **NOTICE**

*If the device is subjected to warm temperatures after being cold (e.g. after transport), condensation may occur inside of it.*

*– In this case, wait approx. 2 hours before you connect and activate it.*

*The isolation pads can produce discolouration on sensitive surfaces.*

*– On parquet, varnished wood and similar surfaces, you should stick felt gliders to the rubber feet of the device or put a blanket under it. This will prevent discolouration of the floor over the long term.*

## **Setup location**

The space in front of or under the TV set is an ideal location.

## **Location tips**

- Select a stable, level base. In case of wall mounting, follow the instructions in the next chapter.
- Make sure that the environment is clean and free from dust.
- Select a location away from heat sources and direct sunlight.
- Do not place any heavy objects on the cables or the device.

## Wall mounting

Proceed with care when mounting the CINEBAR on the wall and follow the instructions below.

You will need the following material to mount the product on a solid stone wall (not included in the package contents):

- 2 dowels ( $\varnothing$  5 mm)
- 2 screws, 4.5 x 55 mm, screw head  $\varnothing$  6–9 mm

### CAUTION

#### **Risk of injury/damage!**

- Only qualified persons may mount the CINEBAR on the wall.
- The device may only be mounted on a suitable, solid wall. Special dowels or anchors may be necessary when mounting the product on lightweight walls. Consult a qualified professional in this case.
- Make sure that there are no cables or pipes in the drilling areas.

*Before you drill, use a metal detector to check the applicable areas. Otherwise, there is a risk of electric shock/short circuit!*

1. Space the two keyhole openings **(11)** in the wall where you would like to mount the CINEBAR at a distance of 59.8 cm apart. Use a ruler, pencil and spirit level for this.

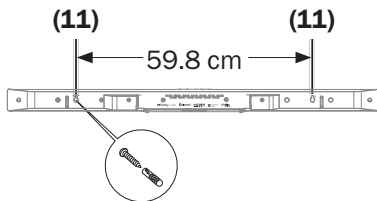

2. Use a metal detector to check the drill areas. If necessary, select another area for mounting.
3. Use a 5 mm rock drill to drill a hole, which is approx. 55 mm deep, at each marked position.
4. Insert a dowel ( $\varnothing$  5 mm) all the way in each drill hole.
5. Screw one screw (4.5 x 55 mm) into each dowel until there is approx. 10–11 mm of space between the wall and the screw head.

6. Press the CINEBAR up against the wall so that the screws vanish in the keyhole openings **(11)**.
7. Now pull the CINEBAR down so that the screws slip into the small slot.
8. If applicable, screw the screws further in or out until the CINEBAR is securely mounted on the wall.

# Connecting

## **⚠ CAUTION**

### **Risk of injury/damage!**

– Lay the cables so that they do not pose a tripping hazard.

## **TV set**

If your TV is equipped with an ARC capable HDMI jack, connect it via the HDMI TV jack **(14)**. You will need an ARC capable HDMI cable for this.

The ARC (audio return channel) HDMI function plays the television audio via HDMI. With some TV sets, this function must be activated in the menu and in most cases, only one HDMI connection is ARC capable (see the user manual for the TV set).

If your TV set does not support the ARC HDMI function, you can also connect it to the analogue AUX IN **(12)** or to the digital OPTICAL IN **(16)** input depending on the configuration.

## **HDMI source**

You can connect a source device with digital sound and picture to the HDMI IN jack **(15)** (e.g. a sat receiver, Blu-ray player, game console).

You do not also have to connect this source device to your TV set. The video signal from this device is looped through and forwarded to the television set via HDMI TV **(14)**.

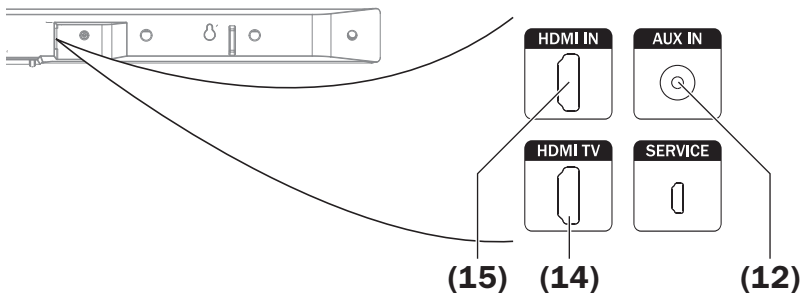

## Optical-digital source

You can connect the optical digital sound output of a source device to the OPTICAL IN jack **(16)**. You will need an optical cable with a TOSLINK plug for this. Your source device requires either an optical 3.5 mm plug or also a TOSLINK plug.

## Analogue source

You can connect a source device with analogue sound (e.g. a CD player or TV set) to the AUX IN jack **(12)**. You will need a stereo cable with a 3.5 mm jack plug to do so.

## Rear speakers and subwoofer

If you use rear speakers (such as “Effekt”) and/or a subwoofer with a wireless connection, activate the connections in the “Speaker” menu (see page 31).

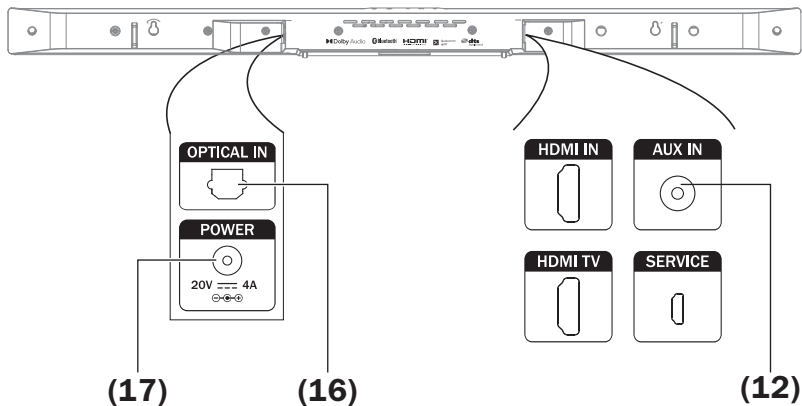

## Power supply

1. Insert the small plug of the enclosed mains adapter **(3)** in the POWER jack **(17)**.

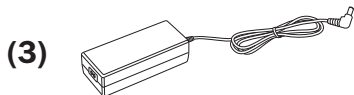

2. Use the mains cord **(4)** to connect the mains adapter to a mains socket.

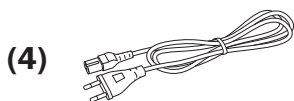

The standby display **(20)** illuminates continuously in red.

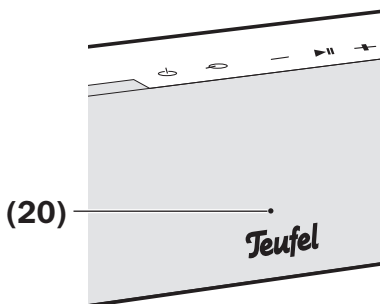

## First activation

At first activation, set the language for showing menu and info texts on the display panel.

1. Switch the CINEBAR on by pushing the button **⏻ (6)/(40)**.  
The lettering “TEUFEL” will appear on the display panel **(19)** and a series of sounds will play. Then the notice “WÄHLE DEINE SPRACHE/SELECT YOUR LANGUAGE” will appear.
2. Use the buttons **+ (10)/(27)** and **- (8)/(29)** to choose between “Deutsch” and “English”.
3. Then push the button **▶|| (9)/(33)**.
4. The notice “READY TO RUMBLE!” will appear on the display panel **(19)**.

Your CINEBAR is now operational.

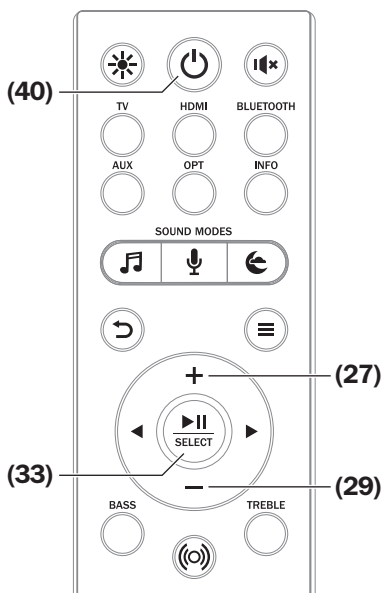
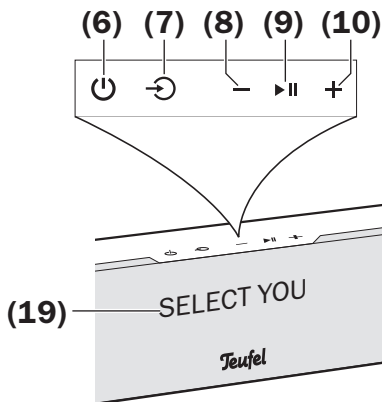



# Operation

## Activating and deactivating

- Use the button **⏻ (6)/(40)** to switch the CINEBAR on or to standby.
- If the TV set connected via HDMI is compatible with HDMI-CEC, the CINEBAR will be activated via the TV set and – providing TV or HDMI IN is selected as the source – also switched off (standby).
- If the CINEBAR does not receive an audio signal for more than 20 minutes, it will automatically switch to standby. You can also set this time via the menu (see „Timer“ on page 32).

## Automatic activation

As soon as a signal is recognised on an audio source, the CINEBAR will wake up and switch to the detected audio source.

You can switch this automatic function on and off in the “System” menu (see “AutoOn” on page 33).

## Selecting a source

- Select the source by pushing the button **↻ (7)** repeatedly.

You can select the source directly with these buttons:

- **HDMI (22)**: HDMI IN jack **(15)**
- **BLUETOOTH (23)**: Bluetooth® Connection
- **OPT (25)**: OPTICAL IN jack **(16)**
- **AUX (37)**: AUX IN jack **(12)**
- **TV (38)**: Sound from the TV via HDMI ARC, OPTICAL IN or AUX IN

The source will appear on the display panel **(19)**.

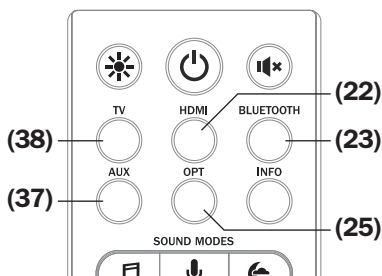

## Adjusting the volume

**i** The volume setting of an external player also affects the volume of the CINEBAR.

- Push the buttons **– (8)/(29)** to decrease and **+ (10)/(27)** to increase the volume. While adjusting the setting, the current value will be shown on the display panel **(19)**.
- In HDMI mode, the volume can also be adjusted with the remote control of the TV set (if HDMI CEC is supported by the TV set).

## Mute

- By pushing the button **🔇 (21)** repeatedly, you can switch the sound off and back on. The notice “Mute” will appear on the display panel **(19)** during muting.
- You can also turn the sound on and off with the button **▶ || (9)/(33)**. With Bluetooth®, playback will be paused in the process.
- You can also activate the sound by adjusting the volume.

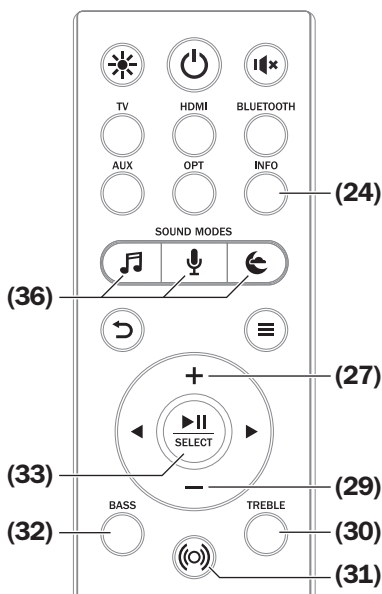
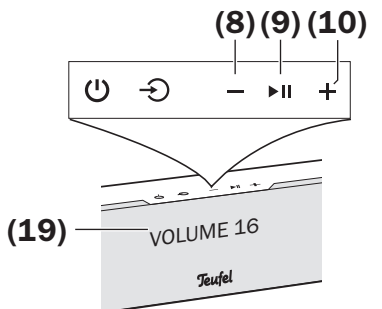

## Showing information

Access the current system parameters with the button **INFO (24)**: Volume (or mute), active source, sound format (PCM, DD 2.0, DD 5.1), sound settings, sound mode (e.g., voice), Dynamore® on/off, status of the wireless speaker, software version.

You also get this display with the “INFO” menu (see page 34).

## Adjusting the tone

You can adjust the tone in two frequency ranges:

- **BASS** – low tones, set with the button **BASS (32)**
  - **TREBLE** – high tones, set with the button **TREBLE (30)**
1. Push the corresponding button.  
The selected range “Bass” or “Treble” will appear briefly on the display panel **(19)**. You will then see the current setting.
  2. Set the desired value within a range from “–10 dB” (decrease) to “+10 dB” (increase) with the buttons **+(10)/(27)** and **–(8)/(29)**.

- The device will return to normal operation after three seconds of button inactivity.

You can also make the same setting on the menu (see “Sound menu” on page 30).

## Dynamore®

Dynamore® is a technology developed by Teufel, which virtually widens stereo panorama beyond the device dimensions. This generates an impressive, spatial and wide-ranging sound.

- Use the button **(31)** to switch Dynamore® on or off.

## Equalizer

Use the buttons **SOUND MODES (36)** to select the predefined sound patterns:

- **Normal**: unchanged sound
- **Voice**: clear sound for messages and magazines
- **Night mode**: Low frequencies are weakened and the overall level is compressed to avoid disrupting the sleep of uninvolved persons as much as possible.

## Dolby Audio and DTS

With playback of Dolby Audio or DTS coded multi-channel tracks, the standby display (20) will illuminate in orange.

## Brightness of the display panel

To set the brightness of the display panel:

1. Push the button ✱ (39).  
You will see the current setting on the display panel (19).
  2. Set the desired value within a range from 10–100 % with the buttons + (10)/(27) and – (8)/(29).
- The device will return to normal operation after three seconds of button inactivity.

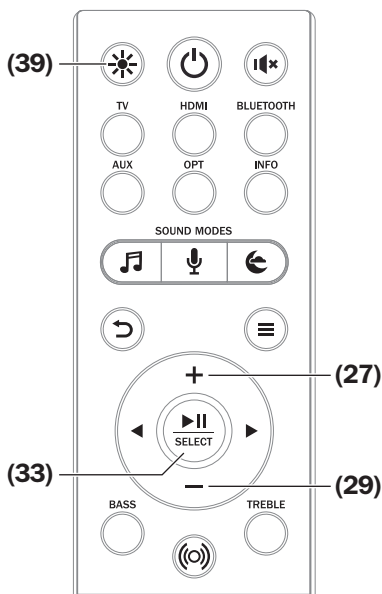
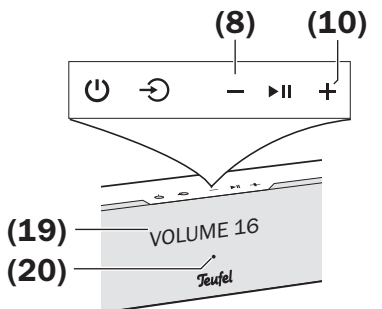

## Menu

Use the menu to configure the functions of your CINEBAR. It will be shown on the display panel (19).

To use the menu:

1. Push the button **≡ (26)** or push the buttons **↻ (7)** and **▶|| (9)** simultaneously for two seconds.

The first menu item “Sound” will appear on the display panel (19). You will see the navigation arrows **⬅ (18)** along the right edge – they will show you where other menu items are.

2. Select the desired sub-menu with the buttons **+ (10)/(27)** and **- (8)/(29)**.

3. Use the buttons **▶ (28)** or **▶|| (9)/(33)** to open the submenu.

4. Use the buttons **+ (10)/(27)** and **- (8)/(29)** to select the desired menu item and open it with the button **▶ (28)** or **▶|| (9)**.

5. Set the desired value with the buttons **+ (10)/(27)** and **- (8)/(29)**.

6. With the buttons **↻ (7)**, **↶ (35)** or **◀ (34)**, you can access the previous menu or exit the menu.

By simultaneously pushing the buttons **↻ (7)** and **▶|| (9)** for two seconds, you also exit the menu.

The submenus are described below.

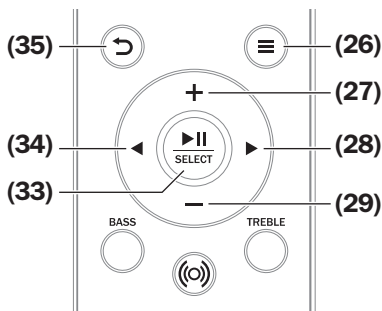
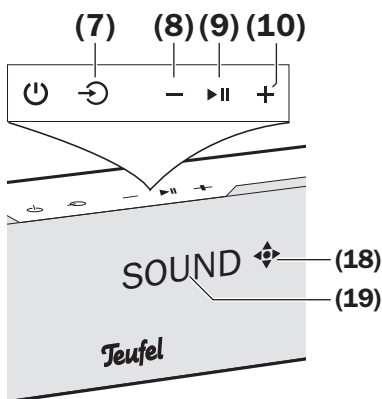

## “Sound” menu

### Treble/bass

Here, you can set the high tones and the bass within a range from “-10 dB” (decrease) to “+10 dB” (increase).

### Mode

Here, you can select the predefined sound patterns of the equalizer:

- **Normal:** Unchanged sound
- **Voice:** Clear sound for messages and magazines
- **Night:** Low frequencies and the overall level are weakened to avoid disrupting the sleep of uninvolved persons as much as possible.

You can also set these sound patterns with the buttons **SOUND MODES (36)** (see page 27).

### Dynamore®

Dynamore® is a technology developed by Teufel, which virtually widens stereo panorama beyond the device dimensions. This generates an impressive, spatial and wide-ranging sound. Possible settings: On, Off

## Advanced

- Upmix

Converts stereo to surround sound: With a pure stereo signal, the rear speakers remain silent. With this function, the system determines the required signals and generates complete surround sound. Possible settings:

**DPL II** – Dolby Pro Logic II

**Direct** – stereo on all channels

**Off** – pure stereo sound

- DRC

With DRC (Dynamic Range Compression), quiet passages are amplified while the volume of loud passages is decreased if the content is accordingly coded. This can be helpful when listening in loud surroundings. Possible settings: On, Off

## “Speaker” menu

### Cinebar

- Dist – Distance to the Cinebar  
Speakers located at different distances to the listening position may disturb the surround sound effect. To compensate these run time differences, you can specify the distance from the listening position to the speakers for all channels. The system calculates the required delays on this basis. Set the distance between your listening position and the CINEBAR here: 0.3–12 m.

### Rears – rear speakers

- Pairing  
As soon as you choose this menu item, the CINEBAR searches for wireless rear speakers that are ready to pair. Start the pairing process to the rear speakers (see the user manual for the speakers).
- Level L/level R  
Here, you can set the relative volume for each of the rear speakers within a range from “–10 dB” (decrease) to “+10 dB” (increase).

- Distance L/distance R  
Set the distance of the rear speakers to the listening position here: 0.3–12 m.

### Ext.Sub – external subwoofer

- Pairing  
As soon as you choose this menu item, the CINEBAR searches for a wireless subwoofer that is ready to pair. Start pairing on your subwoofer (see the user manual for the subwoofer).
- Level  
Here, you can set the relative volume for the external wireless subwoofer within a range from “–10 dB” (decrease) to “+10 dB” (increase).
- Distance  
Set the distance of the subwoofer to the listening position here: 0.3–12 m.

- Phase

You can hereby switch the phase shift (180°) on and off for the subwoofer. Select the setting, with which the subwoofer produces the loudest and clearest sound.

### **Calib.**

You can calibrate your speakers with one another here.

Notice: Only available with rear wireless speakers or an external subwoofer.

- Balance – for setting the sound pattern

You can set the levels for all speakers here.

- Test T. – test tone for calibrating the speakers

Here, you can activate and deactivate a neutral test tone and thus set the speaker levels as described above.

### **“System” menu**

#### **Display**

When operating the device, the display panel (**19**) lights up to the value set under “Bright.” and fades back to the value set under “Fade” after a few seconds.

- Fade – fading intensity of the display

Possible values: Off, 10–100 %  
This value cannot be higher than the value for “Bright”.

- Bright – Set the display brightness

Possible values: 10–100%

#### **Timer**

After a certain configurable period of inactivity, the CINEBAR will automatically switch to standby. Possible values: None (no automatic standby), 15 m, 20 min, 30 min, 45 min, 1 h, 2 h.

#### **De/En**

Select the language for the display panel here.

Possible values: Deutsch, English



## Advanced

Advanced system settings:

- Source TV – source used for TV audio

If your TV set does not emit the television audio via HDMI ARC, you can select another audio input here. If you then select “TV” as source, the CINEBAR will switch to this input:

**TV** – normal connection via the HDMI TV jack **(14)** for ARC capable TV sets. PCM Stereo, Dolby Digital and DTS (if this can be output by the TV set) possible.

**Optical** – for TV sets with an optical or coaxial-digital output. PCM and Dolby or DTS possible.

**AUX** – for TV sets with an analogue audio output or headphone jack. Only analogue signal possible, with or without Dolby Pro Logic II.

- LipSync – synchronises the picture and sound

Digital image processing in the television set requires some time. To ensure that the picture and sound stay in sync, you can configure an audio delay here between 0 and 200 ms.

- AutoOn – Select AutoOn for each source

For each source (TV, HDMI, AUX, Optical, Bluetooth®), you can activate and deactivate automatic activation here (also see page 25).

For the “AUX” source, also set the sensitivity for automatic activation:

**Off** (no automatic activation),  
**Minimal** (only with a high input level),  
**Low, Mid, High,**  
**Maximal** (already at a low input level)

- Standby

When a HDMI source device is connected via the HDMI IN jack **(15)** and this device is switched off, the CINEBAR can also switch to standby.

Possible settings: Yes, No

## Software

Information about software and update

- Version
- Update

These menu items are for updating the software (see “Software update” on page 38).

## Info

Displays the current system parameters: Volume (or mute), active source, sound format (PCM, DD 2.0, DD 5.1), sound settings, sound mode (e.g., language), Dynamore® on/off, status of the wireless speaker, software version.

You will also get this display by pushing the button INFO **(24)**.

## Reset

You can reset some or all parameters to the factory default.

- Bluetooth – deletes the list of known Bluetooth® devices
- Wireless – deletes the list of the paired wireless speakers (rears and subwoofer)
- Full – reset all parameters to the factory default

After selecting one of these items, the corresponding data will be deleted. After a factory reset, the CINEBAR will restart.

# Bluetooth® Mode

Via Bluetooth®, you can connect a compatible external player and the CINEBAR wirelessly. The audio output of your external player is then emitted by the CINEBAR.

The Bluetooth® wireless transmission system has a range of approximately 10 metres that is limited by walls and furnishings. If the connection is cut off, the CINEBAR will attempt to re-establish a connection until you select another source.

## NOTICE



- *Only use the Bluetooth® function in locations where wireless radio transmission is allowed.*
- *Please keep in mind that the Bluetooth® behaviour may differ depending on the external player's operating system.*

## Bluetooth® options

Depending on the device type, your external player/smartphone may also have a menu for Bluetooth® options such as media playback. You can find more information about this in the user manual for your external player/smartphone.

## Pairing and connecting

To play the audio of your external player on your CINEBAR via Bluetooth®, connect the devices with each other. This is called “Pairing”.

1. Enable the Bluetooth® function on your external player (e.g. smartphone).
2. Push the button BLUE-TOOTH (23) or push the button  (7) repeatedly to select Bluetooth® as a source.
3. Push the button BLUE-TOOTH (23) or the button  (7) again and hold it down for approx. 3 seconds to start the pairing process. The notice “Pairing” will appear

on the display panel and the CINEBAR will play a series of sounds.

4. Let your external player/ smartphone scan for Bluetooth® devices. You will find more information about this in the user manual of your external player. After the search run, the “Teufel CINEBAR 11” should also be present in the list of detected devices.
5. Select “Teufel CINEBAR 11” from the list of detected devices.
6. If your external player asks for a code, enter “0000” (four zeros).

Pairing is now complete. “BLUETOOTH” will appear on the display panel and your CINEBAR will now function as a Bluetooth® playback device. The CINEBAR will now play back all sounds that would otherwise be played by your external player/ smartphone.

## Restoring a connection

If your CINEBAR was previously connected to the external player, it is no longer necessary to switch it to pairing mode to connect again. Simply selecting “Teufel CINEBAR 11” on your external player from the list of paired devices is enough.

The CINEBAR saves the connection data of the last 7 external players.

- You can delete the list of these Bluetooth® device (see page 34). External players can only establish a connection in this way once they are paired.

## Interruption of connection

If your external player moves out of the range of your CINEBAR, the Bluetooth® connection will be interrupted. If you are back within range within 120 seconds, the connection will be re-established automatically.

## Terminating the connection





To terminate the Bluetooth® connection, switch the Bluetooth® function on your external player/smartphone off.

## Playback

**i** The volume setting of the external player affects the volume of the CINEBAR.

1. Push the button BLUE-TOOTH (23) or push the button  (7) repeatedly to select Bluetooth® as a source.
2. Turn on the Bluetooth® function on your external player.
3. Start playback on your source device.

You can control playback on your source device. You can also control some functions with the CINEBAR:

- Pause playback:  
Push the button  (9)/(33)
- Continue playback:  
Push the button  (9)/(33) again
- Play next track:  
Push the button  (28)
- Restart the current track:  
Push the button  (34)

- Play previous track:  
Push the button  (34) twice
- If your source device is a smartphone, the Bluetooth® connection will be interrupted in the event of an incoming call and you can make phone calls as usual. After finishing your phone call, the sounds will once again be diverted and played back by your CINEBAR.

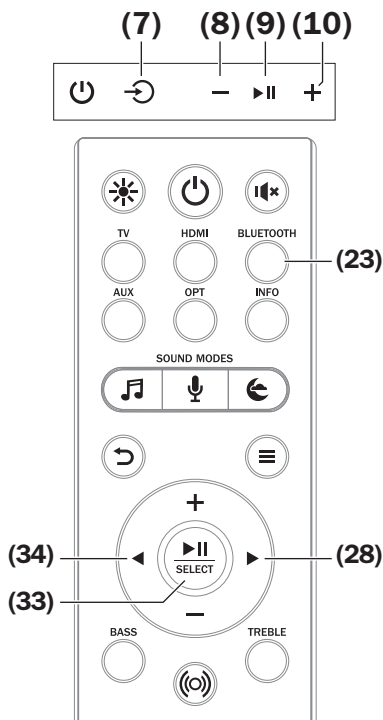

# Software update

The software of the CINEBAR undergoes continual further development.

## Determine the version

- In the menu of the CINEBAR, select the item "System" -> "Software" -> "Version".

Based on the version shown here, you can determine whether new system software is available on our website [www.teufelaudio.com/software-updates.html](http://www.teufelaudio.com/software-updates.html).

## Installing new software

1. Load the new software from our website.
2. Unpack the downloaded file.
3. In the menu of the CINEBAR, select the item "System" -> "Software" -> "Update".  
The message "Update Mod" will appear on the display panel.
4. Now disconnect the mains plug of the CINEBAR and wait until the display panel and the standby display are clear.

5. On the CINEBAR, connect the SERVICE jack (13) with your PC or Mac. For this, you can use any type A USB 2.0 adapter cable to micro B.

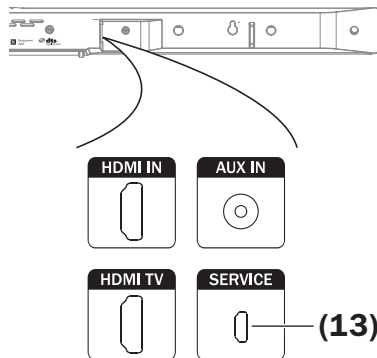

6. Insert the mains plug back in the socket.  
The notice "SYSUPG" will appear on the display panel.
7. A USB drive "TeufelDisk" or just "RAMDISK" will now be displayed on your PC now.

## **NOTICE**

### ***Risk of damage!***

- During the following steps, do not switch the CINEBAR off and do not interrupt the USB connection!*
  - 8. On your PC, copy the unpacked update file to the “TeufelDisk” or “RAMDISK” drive.
  - 9. The update will run in multiple stages and multiple progress messages will appear on the display panel.  
Once the update is complete, the CINEBAR will restart: You will see the lettering “Teufel” on the display panel and will then be asked for the language.
- The new software was installed.

# Care And Cleaning

---

## **NOTICE**

### **External influences may damage or destroy the device.**

- *If the device is to be left unattended for a prolonged period of time (e.g. during a vacation) or if a thunderstorm is forecast, pull the mains plug out of the socket. Otherwise, sudden overvoltage could cause the device to become defective.*
  - *In the event of prolonged absence, remove the batteries from the remote control. Leaked batteries may damage the remote control.*
  - *If possible, only use plain water without any additives. In case of stubborn marks, a mild soap solution may be used.*
- *Do not use caustic cleaning products, white spirit, thinners, petrol or similar under any circumstances. Such cleaning agents may damage the delicate surface of the housing.*
  - *Ideally, you should remove dust or small amounts of dirt with a dry, smooth leather cloth.*
  - *Use a damp cloth to rub off stubborn dirt. Make sure that no liquid penetrates the housing.*
  - *Then immediately wipe the damp surfaces off with a soft cloth without applying pressure.*



# Troubleshooting

The following advice should help you to solve problems. If this does not help, you will find useful information in the detailed FAQs on our website. Otherwise, please contact our hotline (see page 5). Take note of the warranty instructions.

<b>Problem</b>	<b>Possible cause</b>	<b>Solution</b>
No function	No power supply	Check the function of the socket with another device
The device doesn't emit any sound	The wrong source has been selected	Select the right source (page 25)
	The volume is set to "0"	Increase the volume
	The volume of the external player has been set too low	Carefully increase the volume on the external player
No sound in Bluetooth® mode	No Bluetooth® connection	Establish a connection (see page 35)
	CINEBAR has not been selected as the output device	On the external player, select "Teufel CINEBAR 11" as the Bluetooth® output device
	Bluetooth® connection impaired by another radio system (e.g. cordless telephone, Wi-Fi)	Set up the CINEBAR and/or external player in another location. Move to another room to test

No sound during TV playback via HDMI	HDMI jack on the TV does not support the ARC function	Use the jack supporting the ARC function on the TV
	The ARC/CEC function on the TV is not activated	Activate HDMI-CEC and HDMI-ARC in the TV set menu
	Incorrect audio format selected	Select the "PCM" audio format on the TV set
No sound from the rear speakers	With stereo playback, there is no signal for the rear speakers	Switch on "Upmix" (see page 30) so that the system generates signals for the rear speakers

## Declaration Of Conformity

**CE** Lautsprecher Teufel GmbH hereby declares that this product complies with the requirements of the directives 2014/30/EU, 2014/35/EU and 2014/53/EU to the extent they are installed and used in accordance with the instructions of the manufacturer. The full text of the EU declaration of conformity is available at the following Internet address:  
[www.teufelaudio.com/konformitaetserklaerungen.html](http://www.teufelaudio.com/konformitaetserklaerungen.html)

The following radio frequency bands and radio transmitting powers are used in this product:

Radio network	Frequency bands in MHz	Transmission power in mW/dBm
Bluetooth®	2.400–2.483.5	2.5/4
Wireless speaker	2,405-2,477	1/0

# Technical Data

---

## CINEBAR 11:

Dimensions (W × H × D)	950 × 60 × 80 mm
Weight	1.7 kg
Power supply	20 V DC, 80 W max.

## Mains adapter

Manufacturer	Lautsprecher Teufel GmbH
Manufacturer address	Budapester Straße 44, D-301787 Berlin
Commercial registration number	HRB 198813B
Type designation	Mass Power Electronic Limited NBS100A200400M2
Input voltage	100–240 V ~, 50/60Hz, 1.6 A max
Output voltage	20 V DC, 4.0 A, 80 W max.
Average efficiency	87.7 %
Efficiency at 10 % load	86.5 %
Power consumption without load	0.20 W

You can find further technical data on our website. Technical changes reserved!

# Teufel

Please contact our customer service department with any questions, suggestions, or complaints:

**Lautsprecher Teufel GmbH**

**BIKINI Berlin**

**Budapester Str. 44**

**10787 Berlin (Germany)**

Telephone: +44 3308080489

Fax: +4930 300930930

Online support: [www.teufelaudio.com/service](http://www.teufelaudio.com/service)

Contact form: [www.teufelaudio.com/contact](http://www.teufelaudio.com/contact)

No responsibility is assumed for the correctness of this information.

Technical changes, typographical errors and other errors reserved.