

# STARGROVE II 600XL



**EN** - This tent should be erected by at least 2 people

**CZ** - Tento stan by měl být postaven nejméně 2 osoby

**DE** - Dieses Zelt sollte von mindestens zwei Personen aufgestellt werden

**FR** - Cette tente doit être érigée par au moins 2 personnes

**IT** - Questa tenda deve essere eretta da almeno 2 persone

**NL** - Deze tent moet worden omgeven door minstens 2 personen

## PITCHING

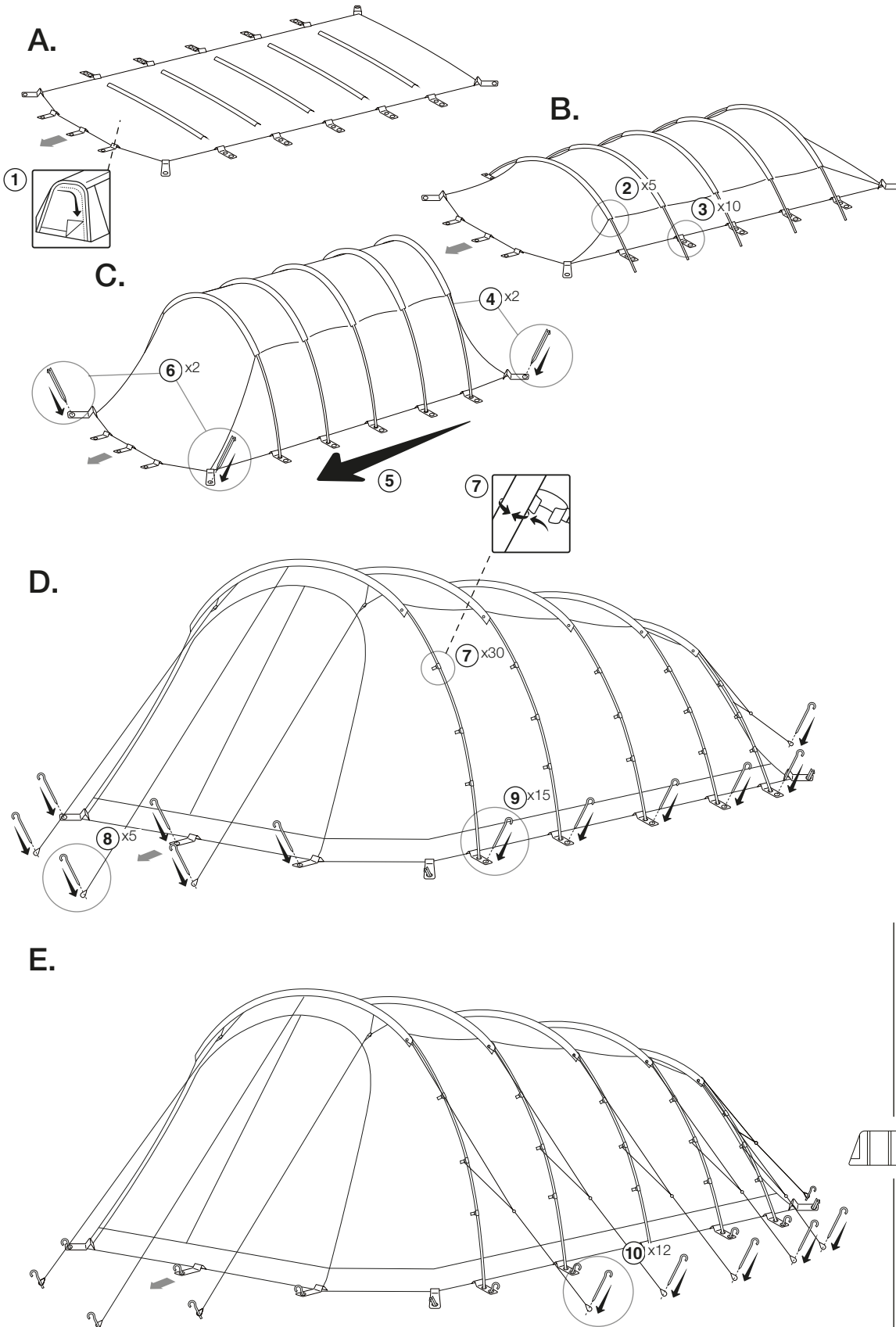

### Poles

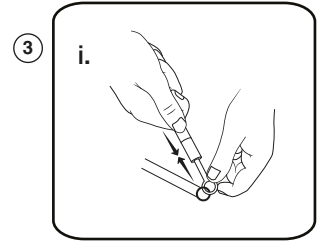
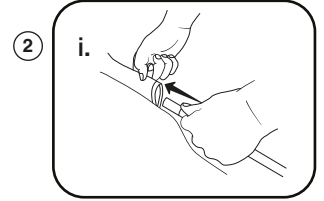

### TBS® II

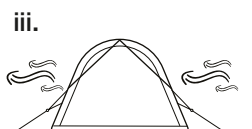
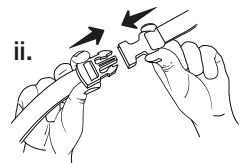

# STARGROVE II 600XL



**EN** - This tent should be taken down by at least 2 people

**CZ** - Těto stan by měl být sundán nejméně 2 osobami

**DE** - Dieses Zelt sollte von mindestens zwei Personen heruntergenommen werden

**FR** - Cette tente doit être prise par au moins 2 personnes

**IT** - Questa tenda deve essere assunta verso il basso da almeno 2 persone

**NL** - Deze tent moet door minstens 2 personen worden genomen

## TAKING DOWN & PACKING

**A.**

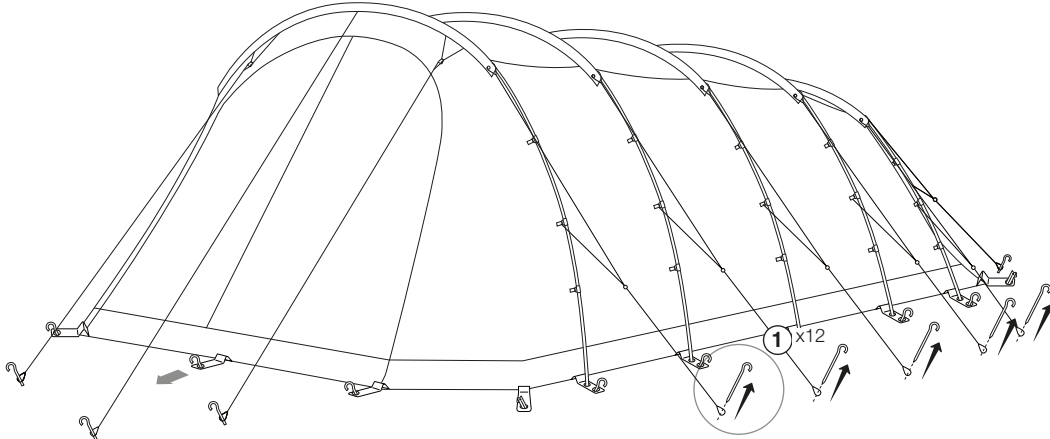

**B.**

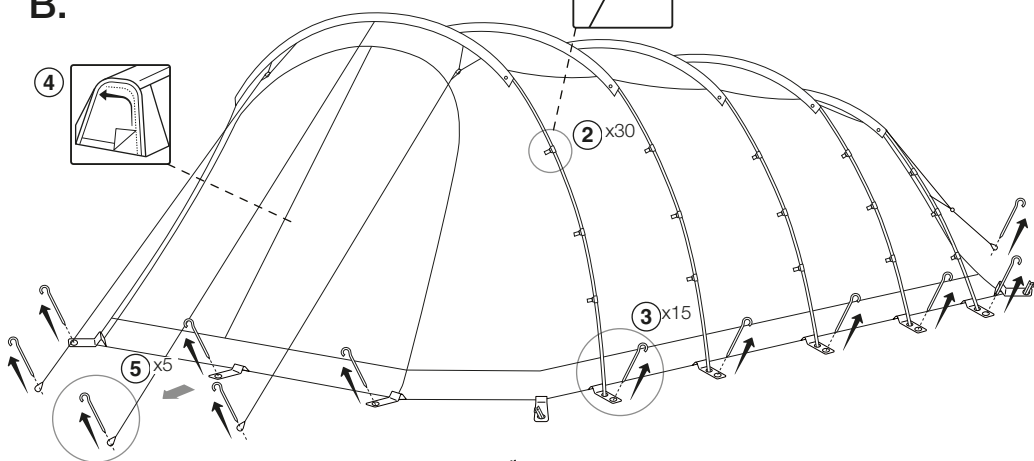

**C.**

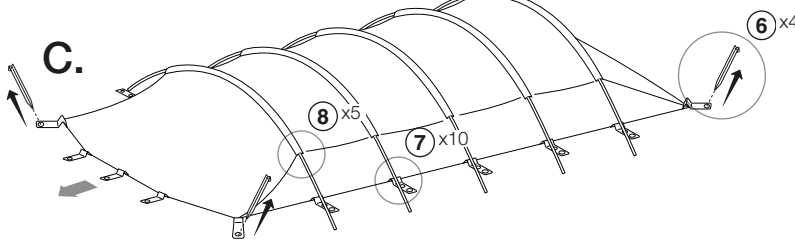

**D.**

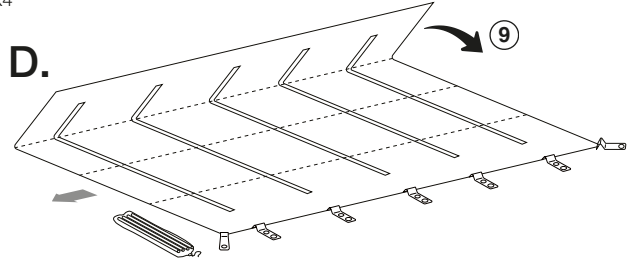

**E.**

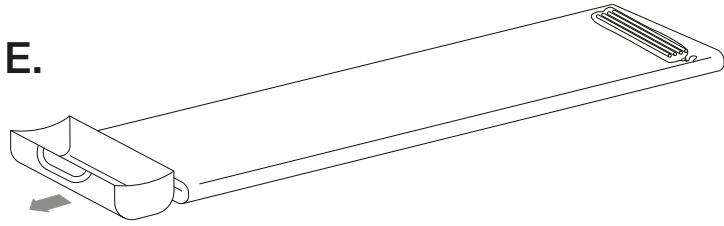

**F.**

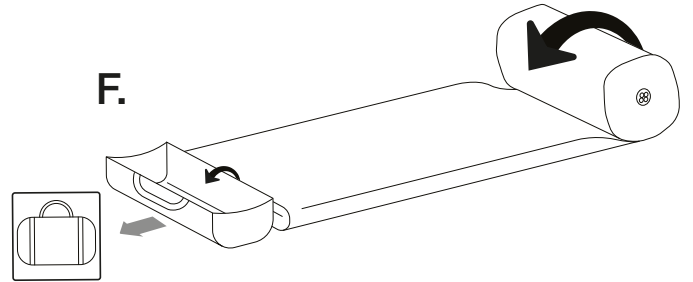

### Poles

