

B 2126
BV 2126

Operator's manual
Manual d'utilisation
Manual de instrucciones

EN (2-20)
FR (21-40)
ES (41-60)

Please read these instructions and make sure you understand them before using the machine.

Lire attentivement et bien assimiler le manuel d'utilisation avant d'utiliser la machine.

Lea detenidamente el manual de instrucciones y asegúrese de entender su contenido antes de utilizar la máquina.

CONTENTS

Contents	
Introduction	2
Key to symbols	3
Safety instructions	4
Description	6
Fuel handling	11
Start and stop	12
Using the blower	13
Maintenance	16
Technical data	19

Note the following before starting:

Jonsered has a policy of continuous product development and therefore reserves the right to modify the design and appearance of products without prior notice. Long-term exposure to noise can result in permanent hearing impairment. Always use approved hearing protection.

This operator's manual describes in detail how to use and service the blower and how to carry out regular maintenance. It also describes which measures should be taken to achieve maximum safety while operating the blower, how the safety devices work and how they should be serviced.

Note! The section of the manual that deals with safety, must be read and understood by all persons who come in contact with the blower.

















This operator's manual has been written for those who need guidance when it comes to fault tracing, thorough servicing and carrying out corrective maintenance of the blower.

There are warning symbols on the blower. Should any of the warning symbols on the blower become disfigured or worn, new ones should be ordered and fitted to the blower as soon as possible. Note that some of the warning symbols may be molded in certain components of the blower.

The blower is used for blowing away leaves and other debris on the ground. When operating the blower, the operator must stand with both feet firmly on the ground.

 **WARNING: Under no circumstances may the design of the machine be modified without the permission of the manufacturer. Always use genuine accessories. Non-authorized modifications and/or accessories can result in serious personal injury or the death of the operator or others. Your warranty may not cover damage or liability caused by the use of non-authorized accessories or replacement parts.**

KEY TO SYMBOLS

Symbol	Description	Location		Symbol	Description	Location	
		Blower	Operator's manual			Blower	Operator's manual
	Checks and/or maintenance shall be carried out after having switched off the engine and disconnected the spark plug.		X		The blower operator must make sure that no bystanders or animals come nearer than 15 meters. Whenever several operators are working in the same work area, they should maintain a safe distance of at least 15 meters from one another.		
	Cleaning at regular intervals is required.		X		Choke		X
	Approved protective goggles or visor must be worn.		X		Refueling		X
	Approved protective goggles or visor, ear protection, and face mask in dusty environments must be worn.	X	X		Stop switch		X
	WARNING! The blower can be dangerous! Careless or improper use can cause serious, even fatal injury.	X	X		Instructions on how to open the inlet cover.		X
	Read the operator's manual carefully and make sure that you understand the contents before using the blower.	X	X		This product is in accordance with applicable EC directives.		X
	WARNING! Make sure that the inlet cover is locked in the closed position or that the vacuum tube is mounted on the blower. Never touch the impeller unless the unit is off, the impeller has stopped moving and the spark plug is disconnected.	X	X		Noise pressure level measured at 7,5 metres distance.		X
	Always wear approved, protective gloves.	X	X		Noise emission to the environment according to the European Community's Directive. The machine's emission is specified in the Technical data section and on the label.		X
	WARNING! The blower may throw objects at high velocity that can ricochet and hit the operator. This may cause serious eye damage.	X	X	Other symbols/decals on the machine refer to special certification requirements for certain markets.			

SAFETY INSTRUCTIONS

WARNING: This machine produces an electromagnetic field during operation. Under some circumstances, this field may interfere with active or passive medical implants. To reduce the risk of serious or fatal injury, we recommend persons with medical implants to consult their physician and the medical implant manufacturer before operating this machine.

Personal safety equipment

Persons who use the blower shall wear the following safety equipment:

1. Approved ear protection.
2. Approved eye protection.
3. Approved protective gloves.
4. Boots or work shoes with a non-slip sole.
5. Face mask when operating the blower in dusty environments.

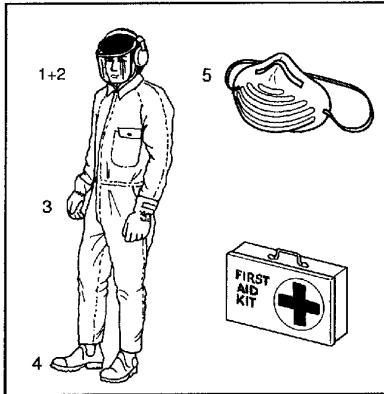

Personal safety

The following instructions apply to persons operating the blower:

- The operator shall have read and understood the contents of this manual.
- Do not wear loose clothing, scarves or neckchains or let long hair hang loose, since these can be drawn into rotating parts of the blower and cause injury.
- Do not operate the blower while under the influence of alcohol, drugs or when you are tired.
- Do not allow minors to operate the blower.
- Always have a first aid kit nearby.

Fuel safety

WARNING: The fuel used to run the blower has the following dangerous characteristics:

1. Volatile liquid: its vapor and exhaust fumes are poisonous.
2. Direct contact can cause skin irritation.
3. It is extremely flammable.

Special safety instructions apply to the type of fuel used for the blower. These instructions are specified under the Fuel handling section.

Muffler

The muffler is designed to give the lowest possible noise level and to direct the engine's exhaust fumes away from the operator. Mufflers fitted with catalytic converters are also designed to reduce harmful exhaust components.

WARNING: The exhaust fumes from the engine are hot and may contain sparks which can start a fire. Never start the machine indoors or near flammable material!

WARNING: Mufflers fitted with catalytic converters become extremely hot during use and after stopping. This also applies at idling speeds. Contact can result in burns to the skin. Be aware of the risk of fire!

Safety equipment

WARNING: The blower must never be used if any of the safety devices or guards are missing, damaged or not in working order.

The blower is equipped with a number of safety devices and guards for the prevention of accidents. These are described in the general description of the blower. The safety devices and guards also require regular inspection and maintenance. These measures and the interval at which they should be carried out are specified in the Maintenance section.

SAFETY INSTRUCTIONS

Safety while operating the blower

- This garden blower/vacuum is only designed for blowing away or removal of leaves and other debris on the ground.
- Do not allow bystanders or animals to be in the work area, i.e. 15 meters from the operator.
- The blower may throw objects at high velocity that can ricochet and hit the operator. This may cause serious eye damage.
- Never point the blower nozzle toward people or animals.
- Stop the engine before fitting or dismantling accessories or other components.
- Never operate the blower if any of the guards are missing.
- Never operate the blower in poorly ventilated spaces where exhaust fumes might otherwise be inhaled.
- Stop the engine before refueling. Move the unit at least 3 meters from fueling site before attempting to start.
- The catalytic muffler is extremely hot while the blower is running and after it has stopped. The same applies when the blower is running at idling speed. Be aware of the danger of fire, especially while operating the blower near flammable materials and/or where flammable fumes are present.
- Be careful, particularly if left hand operation is applied. Avoid any direct body contact with inlet cover area. Keep jewelry, loose clothing, or clothing with loosely hanging straps, ties, tassels, etc., away from inlet cover area.
- Do not operate the blower while standing on a ladder or a stand.
- Secure the machine during transport.

Other safety measures

- Operate the blower only at reasonable hours, i.e. not early in the morning or late at night when people might be disturbed. Comply with times listed in local ordinances. Usual recommendations are 9:00 a.m. to 5:00 p.m., Monday through Saturday.
- Operate the blower at the lowest possible throttle setting to do the job.
- Check the condition of the blower before operation, especially the muffler, air intake and air filter.
- Use a rake or a broom to loosen ground debris before blowing.
- Under dusty conditions, slightly spray the work area with a hose.
- Conserve water by using blowers instead of hoses for many lawn and garden applications, including areas such as roof gutters, screens, patios and gardens etc.
- Watch out for children, pets, open windows or vehicles, and blow debris safely away.
- Use the full nozzle extension so the air stream can work close to the ground.
- After using the blower, clean up and dispose of debris in trash receptacles.

DESCRIPTION

The blower

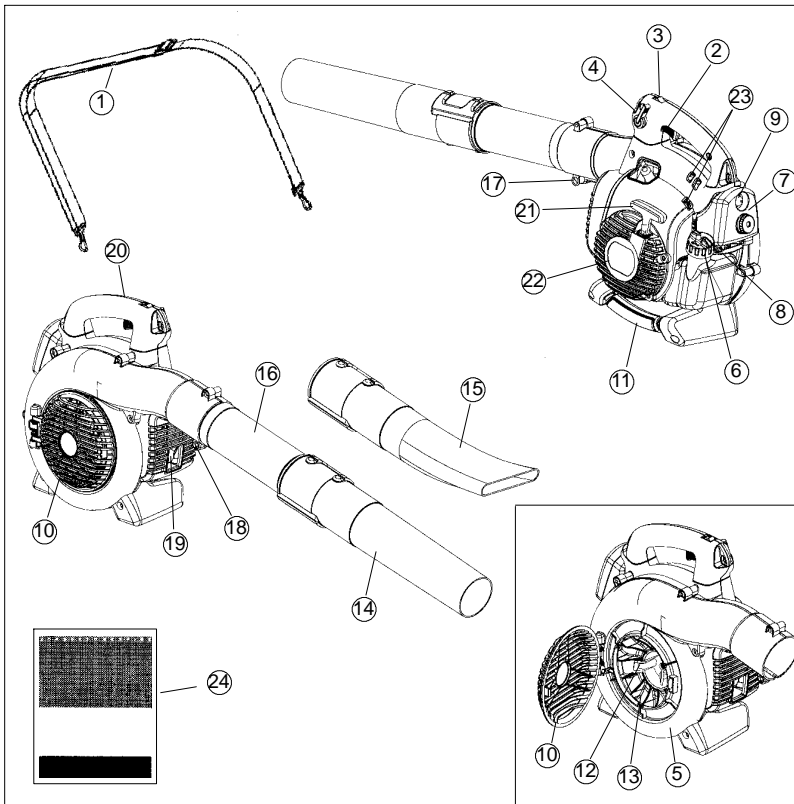

1. Shoulder strap (BV2126)
2. Throttle trigger
3. STOP switch
4. Variable speed control
5. Fan housing
6. Fuel cap
7. Air filter
8. Choke
9. Primer bulb
10. Inlet cover
11. Vacuum handle (BV2126)
12. Cutters (BV2126)
13. Fan impeller
14. Standard nozzle
15. High velocity nozzle (BV2126)
16. Blower tube
17. Tube clamp bolt
18. Tube clamp nuts
19. Muffler
20. Ground wire
21. Starter handle
22. Starter device
23. Carburetor adjustment screws
24. Operator's manual

DESCRIPTION

Accessories (BV2126)

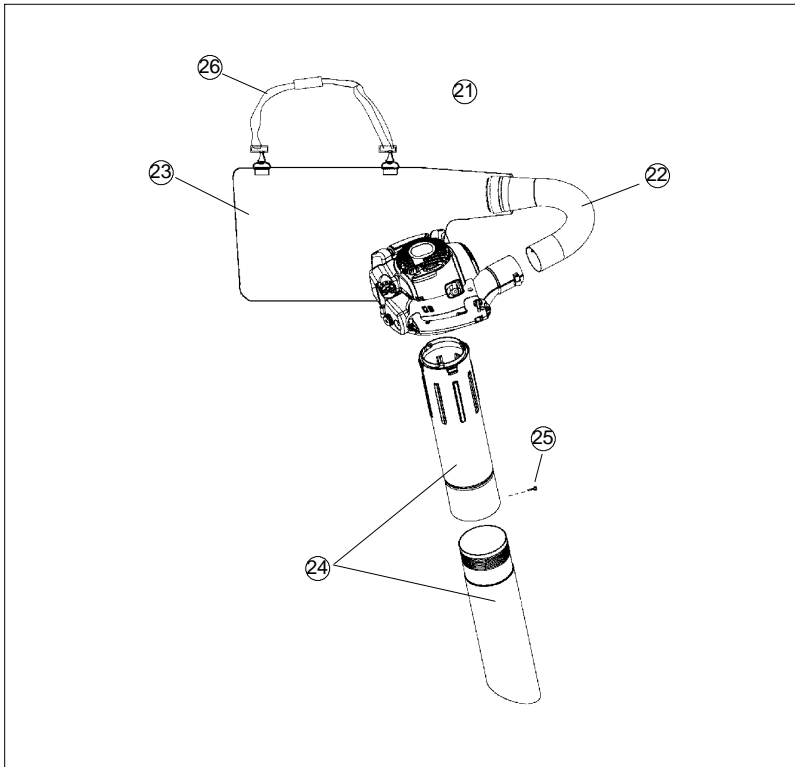

- 21. Vacuum device with collection components consisting of items 22-26 below
- 22. Collection bag tube
- 23. Collection bag
- 24. Vacuum tube in two sections
- 25. Screw
- 26. Shoulder strap

DESCRIPTION

Safety equipment

The following equipment on the blower is designed for protecting personnel and materials. These components should receive special attention whenever you operate, inspect and service the blower.

Stop switch

- The stop switch (A) is used to stop the engine.

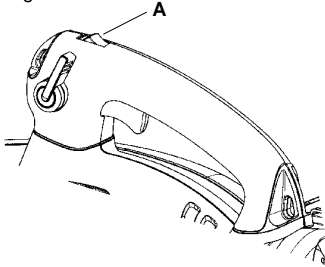

Muffler

- The muffler is designed to give the lowest possible noise level and to direct the engine's exhaust fumes away from the operator. Mufflers fitted with catalytic converters are also designed to reduce harmful exhaust components.
- The engine exhaust fumes are hot and can contain sparks, which may cause fire if they come in contact with dry or flammable material.
- Some blower models, esp. those sold in countries where the climate is dry, are equipped with a spark arresting screen (B). This screen must be cleaned or replaced at specific intervals. See the Maintenance section.

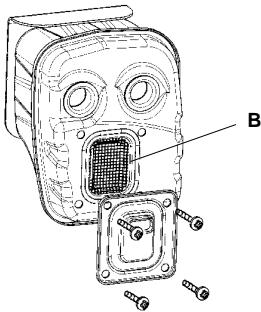

WARNING: The muffler is extremely hot while the engine is running and after it has stopped. DO NOT TOUCH THE MUFFLER IF IT IS HOT! This can cause severe burns.

Other equipment

Throttle trigger

- The speed and the output of the engine are regulated by the throttle trigger (C).

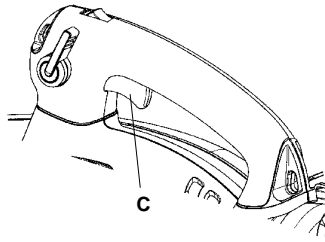

Variable speed control

- The variable speed control (D) is designed to allow setting engine speed as necessary during blower use only.

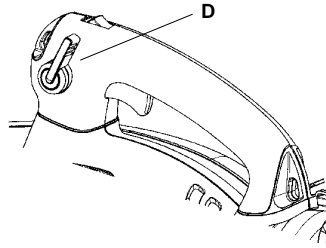

- To avoid causing damage to the unit, DO NOT attempt to use the variable speed control during starting or during vacuum use.

Fan housing

- The blower fan housing (E) and the fan impeller (F) provide high performance air discharge.

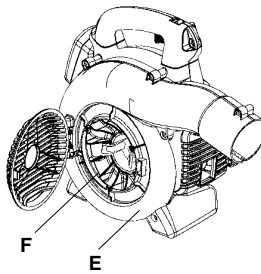

DESCRIPTION

Ground wire

- The ground wire (G) reduces static build-up during operation in dry conditions.

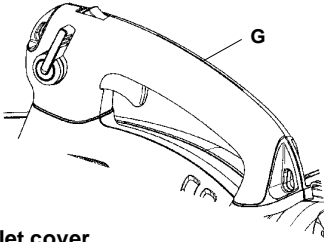

Inlet cover

- An inlet cover (H) is located on the side of the fan housing. Opening this cover allows access for cleaning and inspecting the impeller (BV2126 only). If the vacuum tube is used, it must be fitted to the opening in the inlet cover. To open the inlet cover, use a tool to lift the edge of the cover opposite the hinge (indicated by arrow on inlet cover).

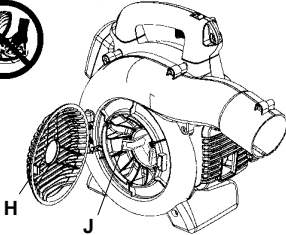

WARNING: Never start the blower if the inlet cover is not closed, is damaged or cannot be closed (except if the vacuum tube is fitted).

Cutters (BV2126)

- Two cutters (J) are fastened to the impeller. The cutters are there to mulch leaves and other debris that have been vacuumed before they enter the collection bag.

Blower tube and nozzle

- The blower tube (K) has a pegged slot mounting system to the unit. To install or remove the blower tube (or collection bag tube for the 125BVX-SERIES), loosen the tube clamp bolt (do not remove nuts from bolt). Align slot in the blower air outlet with the raised rib on the tube and insert tube. Tighten tube clamp bolt.

- The nozzles (L) have a bayonet mount for connection to the blower tube. Air is channeled through the blower tube to the nozzles, where the air discharge velocity increases and the air stream discharge pattern is formed to provide best performance. The length of the blower tube can be adjusted by twisting the nozzle to the left to disengage the bayonet mount and sliding the nozzle to the appropriate position. Twist the nozzle to the right until a click is felt to resecure the nozzle.

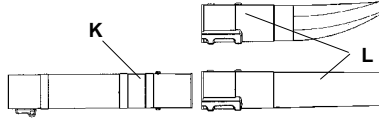

Starter device and starter handle

- The starter device (M) is located on the side of the engine shrouding and engages the crankshaft only when the starter handle (N) is pulled.

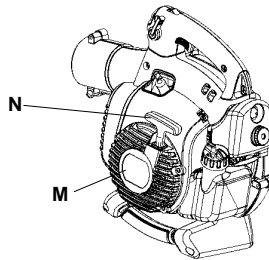

Fuel cap

- The fuel cap (O) is located at the rear of the engine shrouding on the fuel tank and has a seal to prevent fuel from leaking out.

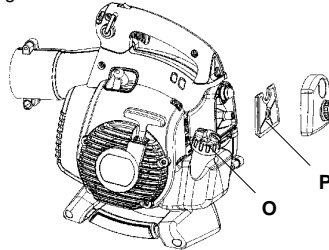

Air filter

- The air filter (P) consists of a fiber filter medium in a resilient frame. The air filter should be cleaned at specific intervals (see Maintenance section). Otherwise, the blower will consume too much fuel, the performance will be reduced and an oily deposit may form on the spark plug electrodes.

DESCRIPTION

Choke

- The choke (Q) is located below the air filter cover and should be used every time the engine is cold-started.

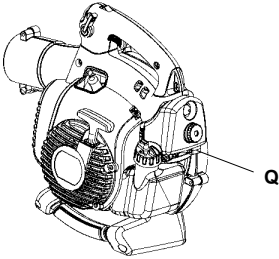

Adjusting the carburetor NOT FOR ALL MODELS

- There are three adjusting screws (R) for adjusting the carburetor:
 - Low speed jet
 - High speed jet
 - Adjustment screw for idling
- Adjusting the carburetor involves adapting the engine to local operating conditions, e.g. climate, altitude, gasoline and type of two-stroke engine oil used. For details about carburetor adjustment, see the Maintenance section.

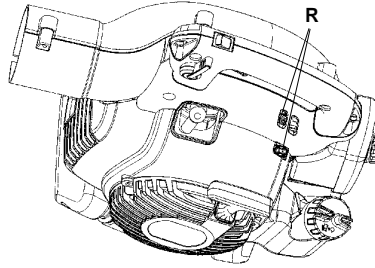

FUEL HANDLING

Fuel mixture

CAUTION! The machine is equipped with a two-stroke engine and must always be run using a mixture of petrol and two-stroke engine oil. It is important to accurately measure the amount of oil to be mixed to ensure that the correct mixture is obtained. When mixing small amounts of fuel, even small inaccuracies can drastically affect the ratio of the mixture.

WARNING: Always ensure there is adequate ventilation when handling fuel.

Petrol



CAUTION! Always use a good quality petrol/oil mixture (at least 90 octane). Use low-emission petrol, also known as alkylate petrol, if it is available.

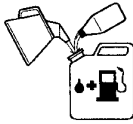

- The lowest octane recommended is 90. If you run the engine on a lower octane than 90, it can result in knocking. This gives rise to a high engine temperature, which can result in serious engine damage.
- When working at continuous high revs, a higher octane rating is recommended.

Two-stroke oil

- For best results and performance, use JONSERED two-stroke oil, which is specially formulated for our two-stroke engines. Mixture 1:50 (2%).
- If JONSERED two-stroke oil is not available, you may use another two-stroke oil of good quality that is intended for air cooled engines. Contact your dealer when selecting an oil. Mixing ratio 1:33 (3%).
- Never use two-stroke oil intended for water-cooled outboard engines, sometimes referred to as outboard oil.
- Never use oil intended for four-stroke engines.

Petrol, litre	Two-stroke oil, litre	
	2% (1:50)	3% (1:33)
5	0,10	0,15
10	0,20	0,30
15	0,30	0,45
20	0,40	0,60

Mixing

- Always mix the gasoline and oil in a clean container intended for fuel.

- Always start by filling half the amount of the gasoline to be used. Then add the entire amount of oil. Mix (shake) the fuel mixture. Add the remaining amount of gasoline.
- Mix (shake) the fuel mixture thoroughly before filling the machine's fuel tank.

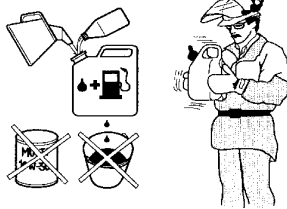

- Do not mix more than one month's supply of fuel at a time.
- If the machine is not used for some time, the fuel tank should be emptied and cleaned.

WARNING: The catalytic converter muffler gets very hot during and after use. This also applies during idling. Be aware of the fire hazard, especially when working near flammable substances and/or vapors.

Fueling



WARNING: Taking the following precautions, will lessen the risk of fire:

- Do not smoke or place hot objects near fuel.
- Always shut off the engine before refueling.
- Always stop the engine and let it cool for a few minutes before refueling.
- When refueling, open the fuel cap slowly so that any excess pressure is released gently.
- Tighten the fuel cap carefully after refueling.
- Always move the machine away from the refueling area before starting.

STARTING AND STOPPING



Min. 10 ft.
(3 m)

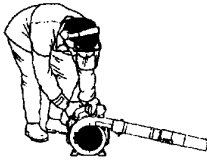

- Clean the area around the fuel cap. Contamination in the tank can cause operating problems.
- Ensure that the fuel is well mixed by shaking the container before filling the tank.

Starting and stopping



WARNING: Never start the blower if the inlet cover is not closed, is damaged or cannot be closed (except if the vacuum tube is fitted).

Cold engine

Primer bulb: Press the primer bulb 10 times until fuel begins to fill the bulb. The primer bulb need not be completely filled.

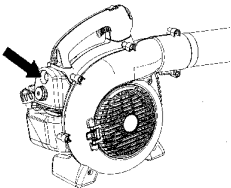

Choke: Move the blue engine choke lever over to the FULL CHOKE (closed) position.

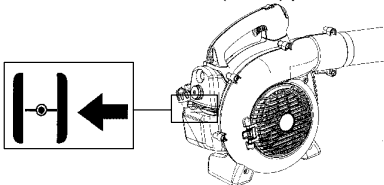

Starting: Hold the body of the machine on the ground using your left hand (**CAUTION!** Not with your foot!). Firmly grip the starter rope handle with your right hand. **DO NOT squeeze throttle trigger.** Slowly pull out the cord until you feel some resistance (the starter pawls grip); then quickly and powerfully pull the cord.

WARNING: Never wrap the starter cord around your hand.

Pull starter handle until engine attempts to run, but no more than 3 pulls. Move choke to ½ position and pull the cord until the engine starts and runs. Allow the engine to warm up for approximately 10 seconds; then, move the choke to the OFF CHOKE (opened) position.

NOTE: If engine dies, return blue engine choke lever to the closed position and repeat starting steps.

CAUTION! Do not pull the starter cord all the way out and do not let go of the starter handle when the cord is fully extended. This can damage the machine.

Warm engine

With a warm engine, squeeze and hold the throttle trigger. Move choke to ½ position. Pull starter rope sharply while squeezing throttle trigger until engine runs. Move the choke to the OFF CHOKE (opened) position.

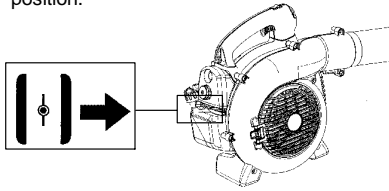

Stopping

To stop the engine, push and release the engine STOP switch (S). The switch will automatically return to the ON position. Wait 7 seconds before attempting to restart unit to allow switch to reset.

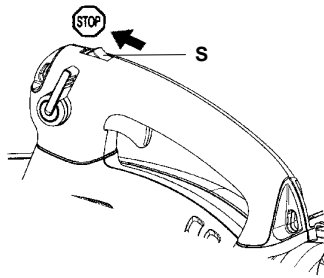

USING THE BLOWER

To blow away debris on the ground

Fitting the blower tube and nozzle on the blower

WARNING: When fitting the blower tube and nozzle, the engine must be switched off.

The blower tube (T) has a pegged slot mounting system to the unit. To install or remove the blower tube (or collection bag tube for the 125BVX-SERIES), loosen the tube clamp bolt (do not remove nuts from bolt). Align slot in the blower air outlet with the raised rib on the tube and insert tube. Tighten tube clamp bolt.

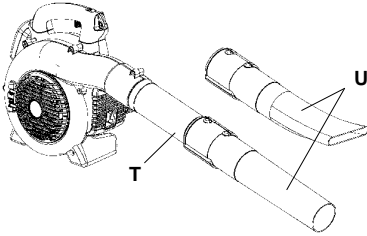

The nozzles (U) have a bayonet mount for connection to the blower tube. Air is channeled through the blower tube to the nozzles, where the air discharge velocity increases and the air stream discharge pattern is formed to provide best performance. The length of the blower tube can be adjusted by twisting the nozzle to the left to disengage the bayonet mount and sliding the nozzle to the appropriate position. Twist the nozzle to the right until a click is felt to re-secure the nozzle.

Blowing

Before you begin blowing, put on the required safety equipment.

WARNING: When working with the blower, wear the required personal safety equipment:

1. Hearing protection.
2. Eye protection.
3. Protective gloves.
4. Face mask in dusty environments.



BV2126 can be used with a shoulder strap for extra comfort. The strap should be worn over the shoulder as shown.

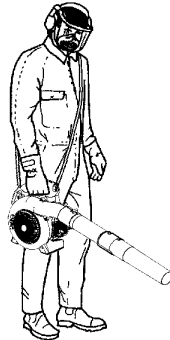

WARNING: Never point the blower nozzle at people or animals. The high-velocity air stream can contain particles that may cause serious injury, especially if the blower has previously been used for vacuuming. Be careful, particularly if left hand operation is applied. Avoid any direct body contact with inlet cover area. Keep jewelry, loose clothing, or clothing with loosely hanging straps, ties, tassels, etc., away from inlet cover area.

USING THE BLOWER

WARNING: Never start the blower if the inlet cover is not closed, is damaged or cannot be closed (except if the vacuum tube is fitted).

WARNING: Do not operate the blower while standing on a ladder or a stand.

Start the blower as described in the Starting and Stopping section. Work according to the following instructions:

1. Never blow air toward fixed objects such as walls, large rocks, automobiles and fences.
2. When working inside corners, blow from the corner and inward toward the center of the work area. Otherwise, debris can fly up in your face and cause eye injury.
3. Never point the blower nozzle at delicate plants.

Standard nozzle

The standard nozzle (V) is included with the B2126 and BV2126. When greater accuracy and high air stream concentration is desired, use the standard nozzle.

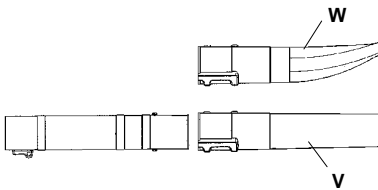

High-velocity nozzle

The high-velocity nozzle (W) is an accessory of the blower (included with the BV2126).

When a wider air stream and greater air velocity is desired, use the high-velocity nozzle.

To vacuum debris from the ground (BV2126)

Fitting the collection bag with the various vacuum tubes

The vacuuming device is an accessory (included with the BV2126).

WARNING: When fitting the tubes to the blower, the engine must be switched off.

1. Open the collection bag. Insert the collection bag tube from inside the bag to fit in the vacuum inlet opening of the bag as shown. Ensure elastic is seated in groove. Close the zipper on the bag.
2. Remove the blower tube and install the collection bag tube. Tighten tube clamp bolt. Attach the carrying strap to the collection bag loops.
3. Align arrows on lower vacuum tube and upper vacuum tube. Push lower vacuum tube into upper vacuum tube until the lower tube is securely seated in the upper tube (about 3 inches/7 cm). Permanently assemble the two tubes together with the supplied screw.

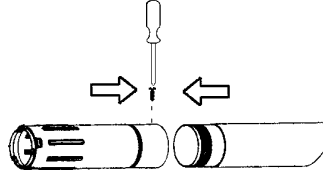

4. Open the cover on the side of the blower by using a screwdriver to pry up under the edge of the cover on the side opposite the hinge (indicated by arrow on inlet cover).
5. Press the vacuum tubes in the large opening at the underside of the blower and align the tabs with the slots in the tube. Turn it until the bayonet mount locks (lock symbols  align).

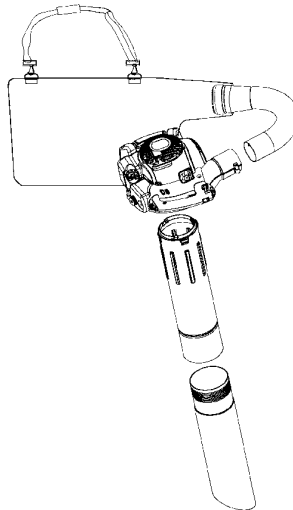

USING THE BLOWER

Vacuuming

Before vacuuming, put on the required safety equipment.

WARNING: When working with the blower, wear the required personal safety equipment:

1. Hearing protection.
2. Eye protection.
3. Protective gloves.
4. Face mask in dusty environments.



When operating the blower, the collection bag must be supported by the shoulder strap. The strap should be worn over the shoulder as shown.



WARNING: Always check that the collection bag is intact and the zipper is closed before starting the blower. Never use a damaged bag. There is risk of injury due to flying debris. Be careful, particularly if left hand operation is applied. Avoid any direct body contact with the exhaust outlet area.

WARNING: Never start the blower if the inlet cover is not closed, is damaged or cannot be closed (except if the vacuum tube is fitted).

WARNING: Do not operate the blower while standing on a ladder or a stand.

Start the blower as described in the Starting and Stopping section. Work according to the following instructions:

1. Do not vacuum large solid objects that can damage the fan, such as wood, cans (tins) or lengths of string or ribbon.
2. Do not let the vacuum tube strike the ground.
3. The collection bag can be emptied by first stopping the unit and then opening the zipper on the side.

MAINTENANCE

Maintenance Safety

The owner is responsible for the performance of all required maintenance as defined in the operator's manual. Disconnect the spark plug before performing maintenance, except carburetor adjustments.

Carburetor

Your Jonsered product has been designed and manufactured to specifications that reduce harmful emissions. After the engine has used 8-10 tanks of fuel, the engine will be run-in. To ensure that it continues to run at peak performance and to minimize harmful exhaust emissions after the run-in period, ask your servicing dealer to adjust your carburetor.

Function



- The carburetor governs the engine's speed via the throttle control. Air and fuel are mixed in the carburetor.
- The T-screw (X) regulates the throttle setting at idle speed. If the T-screw is turned clockwise this gives a higher idle speed; turning it counterclockwise gives a lower idle speed.

Basic setting

- The basic carburetor settings are adjusted during testing at the factory. Fine adjustment should be carried out by a skilled technician.

Recommended idle speed:

See "Technical data" section.

Recommended max. speed:

See "Technical data" section.

Fine adjustment of the idle speed-T

Adjust the idle speed using the idle adjustment T-screw if it is necessary to readjust. The idle speed is correctly adjusted when the engine will run smoothly in every position.

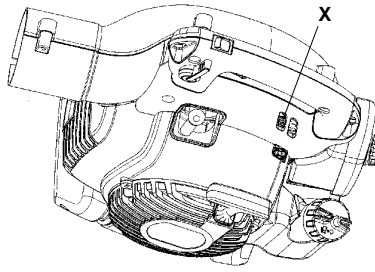

Muffler

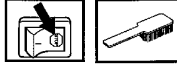

Some mufflers are fitted with catalytic converters. See the Technical data section to find out if your machine is equipped with a catalytic converter.

The muffler is designed to dampen the noise level and to direct the exhaust fumes away from the user. The exhaust fumes are hot and can contain sparks, which can result in fire if the exhaust fumes are directed towards a dry and flammable material.

Some mufflers are equipped with a special spark arresting screen (Y). If your machine is fitted with this type of screen, it should be cleaned regularly. To access the screen, remove the outlet cover on the front of the muffler. Use a wire brush to clean the screen. On mufflers without a catalytic converter the screen should be cleaned weekly, or replaced if necessary. On mufflers fitted with a catalytic converter the screen should be checked and cleaned monthly. If the screen is damaged it should be replaced. If the screen is frequently blocked, this can be a sign that the function of the catalytic converter is impaired. Contact your dealer to inspect the muffler. A blocked screen will cause the engine to overheat resulting in damage to the cylinder and piston.

CAUTION! Never use a machine that has a faulty or loose muffler. Ensure the muffler bolts are tight.

MAINTENANCE

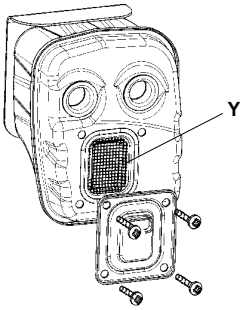

WARNING: Mufflers fitted with catalytic converters get very hot during use and remain so for some time after stopping. This also applies at idle speed. Contact can result in burns to the skin. Remember the risk of fire!

WARNING: Bear in mind that: Engine exhaust fumes contain carbon monoxide, which can cause carbon monoxide poisoning. For this reason you should not start or run the machine indoors, or anywhere that is poorly ventilated. The exhaust fumes from the engine are hot and may contain sparks which can start a fire. Never start the machine indoors or near flammable material!

WARNING: The inside of the muffler contain chemicals that may be carcinogenic. Avoid contact with these elements in the event of a damaged muffler.

Cooling system

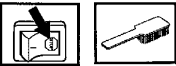

The engine is equipped with a cooling system for maintaining the right operating temperature.

The cooling system consists of the following components:

1. Air intake on the starter device (Z).
2. Fan blades on the flywheel (AA).
3. Cooling fins on the cylinder (BB).
4. Cylinder cowling (guides cooling air flow against cylinder surfaces).

Clean the cooling system by brushing once a week, or more often, if necessary.

A dirty or blocked cooling system will cause the blower to overheat and this will damage the cylinder and piston.

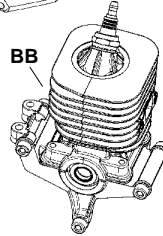
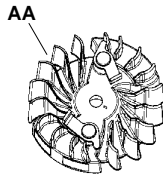
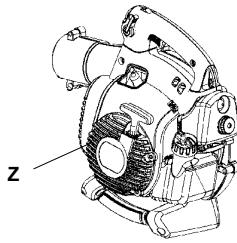

Air filter



The air filter (CC) must be regularly cleaned to remove dust and dirt in order to avoid:

- Carburetor malfunctions
- Starting problems
- Loss of engine power
- Unnecessary wear to engine parts
- Excessive fuel consumption
- Elevated content of harmful exhaust fumes.

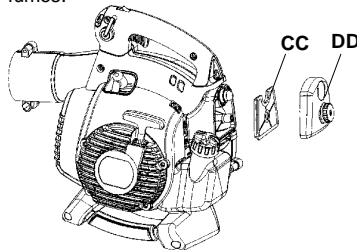

Clean the filter every 25 hours, or more regularly if conditions are exceptionally dusty.

Cleaning the air filter

Remove the air filter cover (DD) and take out the filter. Wash it clean in warm, soapy water. Rinse thoroughly. Ensure that the filter is dry before reinstalling it.

An air filter that has been in use for a long time cannot be cleaned completely. The filter must therefore be replaced with a new one at regular intervals.

CAUTION! A damaged air filter must always be replaced.

MAINTENANCE

Spark plug



The spark plug condition is influenced by:

- Incorrect carburetor adjustment.
- An incorrect fuel mixture (too much or incorrect type of oil).
- Poor quality gasoline and/or oil
- A dirty air filter.

These factors cause deposits on the spark plug electrodes, which may result in operating problems and starting difficulties.

If the machine is low on power, difficult to start or runs poorly at idle speed: always check the spark plug first before taking any further action. If the spark plug is dirty, clean it and check that the electrode gap is 0,6 mm. The spark plug should be replaced after about a month in operation or earlier if necessary.

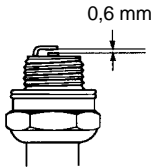

CAUTION! Always use the recommended spark plug type! Use of the wrong spark plug can damage the piston/cylinder.

Maintenance schedule

Below you will find some general maintenance instructions.

Daily maintenance

- Clean the exterior surfaces of the blower.
- Check that the variable speed control and the throttle trigger function in a safe manner. Replace damaged parts.
- Check that the stop switch works properly. Replace if necessary.
- Clean the air filter. Replace if necessary.
- BV2126: Check that the inlet cover can be locked in the closed position. Carefully check that the fan impeller is clean, especially if the blower has been used for collecting debris (vacuuming).
- Check that all nuts and screws are properly tightened.
- Check that all the housings are free of cracks. Replace damaged parts.
- BV2126: Check that the collection bag is intact and that the zipper works. Replace it if necessary.

Weekly maintenance

- Check the condition of the starter device, the starter cord and the tensioning spring. Replace damaged parts.
- Check the condition of the air intake at the starter device. Remove debris if it is clogged.
- Clean the outside of the spark plug. Remove it and check the electrode gap. Adjust the gap to 0,6 mm, or replace the spark plug. Use resistor spark plug Champion RCJ-8Y or equivalent.
- Clean the fan blades on the flywheel.
- Clean or replace the spark arresting screen (not on mufflers with a catalytic converter).
- Clean the carburetor area.
- Clean the air filter.

Monthly maintenance

- Clean the fuel tank.
- Clean the outside of the carburetor and the area around it.
- Clean the fan blades on the flywheel and the area around it.
- Check fuel lines for cracks or other damage. Change if necessary.
- Change the fuel filter in fuel tank.
- Check all cables and connections. Replace damaged parts.
- Replace the spark plug. Use spark plug Champion RCJ-8Y or equivalent.
- Change the air filter.

TECHNICAL DATA

Technical data

	B2126	BV2126
Engine		
Cylinder volume, cm ³	28	28
Cylinder bore, mm	35	35
Stroke, mm	28,7	28,7
Idle speed, rpm	2800-3200	2800-3200
Max. speed - blowing, rpm:	8600	8600
Max. speed - vacuuming, rpm:	--	7500
Max. engine output, acc. to ISO 8893, kW	0,8	0,8
Catalytic converter muffler	Yes	Yes
Ignition system		
Spark plug	Champion RCJ-6Y	Champion RCJ-6Y
Electrode gap, mm	0,6	0,6
Fuel and lubrication system		
Fuel tank capacity, liter	0,5	0,5
Weight		
Weight, without fuel but with blower tube and standard nozzle fitted, kg	4,3	4,4
Noise emissions (see note 1)		
Sound power level, measured dB(A)	106	106
Sound power level, guaranteed L _{WA} dB(A)	107	107
Noise levels (see note 2)		
Equivalent sound pressure level at the operators' ear, measured according to ISO 22868, dB(A)		
Equipped with blower tubes and nozzle (original)	94	99
Equipped with vacuum tubes (original)	--	99
Vibration levels (see Note 3)		
Equivalent vibration levels (a _{hv,eq}) at handles, measured according to ISO 22867, m/s ²		
Equipped with blower tubes and nozzle (original)	8,3	8,3
Equipped with vacuum tubes (original), left/right	--/--	6,4/8,3

Note 1: Noise emissions in the environment measured as sound power (L_{WA}) in conformity with EC directive 2000/14/EC. Reported sound power level for the machine has been measured with the original cutting attachment that gives the highest level. The difference between guaranteed and measured sound power is that the guaranteed sound power also includes dispersion in the measurement result and the variations between different machines of the same model according to Directive 2000/14/EC.

Note 2: Reported data for equivalent sound pressure level for the machine has a typical statistical dispersion (standard deviation) of 1 dB(A).

Note 3: Reported data for equivalent vibration level has a typical statistical dispersion (standard deviation) of 1 m/s².

Fan	B2126	BV2126
Type	Radial fan	Radial fan
Max. air velocity, m/s (km/h), standard nozzle	60 (217)	60 (217)
Max. air velocity, m/s (km/h), high velocity nozzle*	76 (273) 76 (273)	76 (273)
Air volume - blowing, m ³ /h (cfm)	722 (425)	722 (425)
Air volume - vacuuming, m ³ /h (cfm)	--	756 (445)

*optional accessory for some models

TECHNICAL DATA

Model B2126	
Approved accessories	Part. no.
High velocity nozzle	545 119 502

DECLARATION OF CONFORMITY

EC Declaration of Conformity (Only applies to Europe)

We, **Husqvarna AB**, SE-561 82 Huskvarna, Sweden, tel: +46-36-146500, as authorised representative in the Community, declare that the garden blower/vacuum models **Jonsered B2126** and **BV2126** with serial numbers dating from 2009 and onwards (the year is clearly stated on the rating plate, followed by the serial number), comply with the requirements of the **COUNCIL'S DIRECTIVES**:

of 17 May 2006 "relating to machinery" **2006/42/EC**;

of 15 December 2004 "relating to electromagnetic compatibility" **2004/108/EC**, and applicable supplements; and

of 8 May 2000 "relating to the noise emissions in the environment" in accordance with Annex V of **2000/14/EC**. For information relating to noise emissions, see Technical data section.

The following standards have been applied: **EN ISO 12100-1/A1:2009**, **EN ISO 12100-2/A1:2009**, **CISPR 12:2007**.

SMP, The Swedish Machinery Testing Institute, Fyrisborgsgatan 3 S-754 50 Uppsala, Sweden, has performed voluntary type examination on behalf of Husqvarna AB. The certificate(s) are numbered: **SEC/09/2023**.

09-11-01

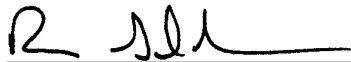

Ronnie E. Goldman, Director of Engineering
Authorized representative for Husqvarna AB and
responsible for technical documentation